

Mitsubishi Programmable Controller

Transition from MELSEC-I/OLINK to AnyWire DB A20 Handbook

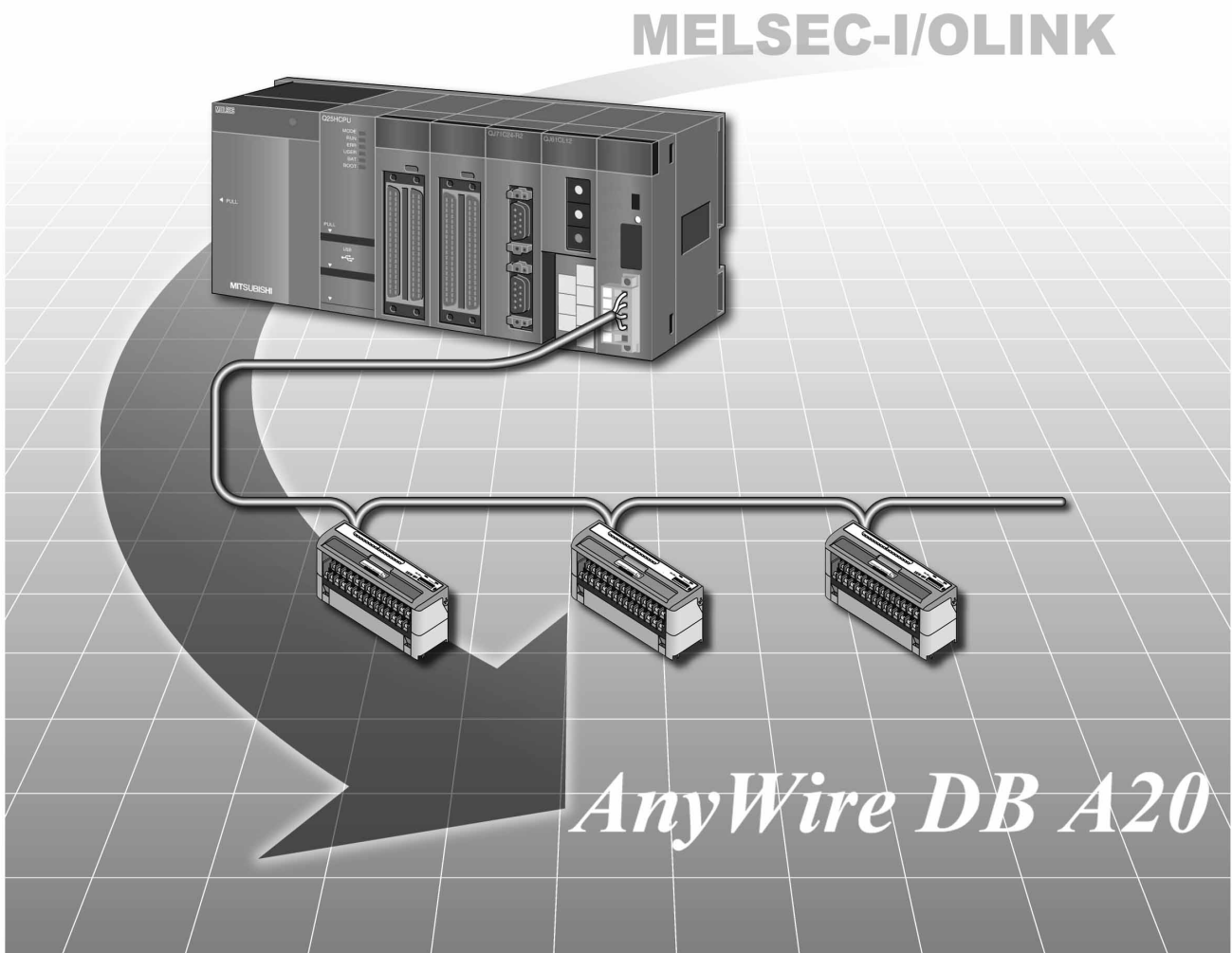

May. 2015 Edition

● SAFETY PRECAUTIONS ●

(Read these precautions before using this product.)

Before using this product, please read this manual and the relevant manuals carefully and pay full attention to safety to handle the product correctly.

In this manual, the safety precautions are classified into two levels: "⚠ WARNING" and "⚠ CAUTION".



Indicates that incorrect handling may cause hazardous conditions, resulting in death or severe injury.



Indicates that incorrect handling may cause hazardous conditions, resulting in minor or moderate injury or property damage.

Under some circumstances, failure to observe the precautions given under "⚠ CAUTION" may lead to serious consequences. Observe the precautions of both levels because they are important for personal and system safety.

Make sure that the end users read this manual and then keep the manual in a safe place for future reference.

[Design Precautions]

WARNING

- Configure safety circuits external to the programmable controller to ensure that the entire system operates safely even when a fault occurs in the external power supply or the programmable controller. Incorrect output or malfunction due to a communication failure may result in an accident.
 - (1) Emergency stop circuits, protection circuits, and protective interlock circuits for conflicting operations (such as forward/reverse rotations or upper/lower limit positioning) must be configured external to the programmable controller.
 - (2) When the programmable controller detects the following problems, it will stop calculation and turn off all outputs in the case of (a).

In the case of (b), it will hold or turn off all outputs according to the parameter setting.

Note that the A series module will turn off the output in either of cases (a) and (b).

	Q series module	A/AnS series module
(a) The power supply module has over current protection equipment and over voltage protection equipment.	Output OFF	Output OFF
(b) The CPU module self-diagnosis functions, such as the watchdog timer error, detect problems.	Hold or turn off all output according to the parameter setting.	Output OFF

Also, all outputs may be turned on if an error occurs in a part, such as an I/O control part, where the CPU module cannot detect any error. To ensure safety operation in such a case, provide a safety mechanism or a fail-safe circuit external to the programmable controller. For a fail-safe circuit example, refer to the MELSEC-Q CPU User's Manual (Hardware Design, Maintenance and Inspection).

- (3) Outputs may remain on or off due to a failure of a component such as a transistor in an output circuit. Configure an external circuit for monitoring output signals that could cause a serious accident. Configure an external circuit for monitoring output signals that could cause a serious accident.

[Design Precautions]

WARNING

- In an output module, when a load current exceeding the rated current or an overcurrent caused by a load short-circuit flows for a long time, it may cause smoke and fire. To prevent this, configure an external safety circuit, such as a fuse.
- Configure a circuit so that the programmable controller is turned on first and then the external power supply.
If the external power supply is turned on first, an accident may occur due to an incorrect output or malfunction.
- In the case of a communication failure in the network, the status of the error station will be as follows:
Check the communication status information and configure an interlock circuit in the sequence program to ensure that the entire system will operate safely.
Incorrect output or malfunction due to a communication failure may result in an accident.
 - (1) All inputs from remote I/O stations are turned off.
 - (2) All outputs from remote I/O stations are turned off.
- When connecting a peripheral with the CPU module or connecting an external device, such as a personal computer, with an intelligent function module to modify data of a running programmable controller, configure an interlock circuit in the program to ensure that the entire system will always operate safely.
For other forms of control (such as program modification or operating status change) of a running programmable controller, read the relevant manuals carefully and ensure that the operation is safe before proceeding.
Especially, when a remote programmable controller is controlled by an external device, immediate action cannot be taken if a problem occurs in the programmable controller due to a communication failure.
To prevent this, configure an interlock circuit in the program, and determine corrective actions to be taken between the external device and CPU module in case of a communication failure.

CAUTION

- Use the programmable controller in an environment that meets the general specifications in a product manual.
Failure to do so may result in electric shock, fire, malfunction, or damage to or deterioration of the product.
- Do not install the control lines or communication cables together with the main circuit lines or power cables.
Keep a distance of 100mm or more between them.
Failure to do so may result in malfunction due to noise.
- During control of an inductive load such as a lamp, heater, or solenoid valve through an output module, a large current (approximately ten times greater than normal) may flow when the output is turned from off to on. Therefore, use a module that has a sufficient current rating.

[Installation Precautions]

CAUTION

- Connectors for external devices must be crimped with the tool specified by the manufacturer, or must be correctly soldered. Securely connect the connector to the module.
- Use the programmable controller in an environment that meets the general specifications in the QCPU User's Manual (Hardware Design, Maintenance and Inspection).
Failure to do so may result in electric shock, fire, malfunction, or damage to or deterioration of the product.
- To mount the module, while pressing the module mounting lever located in the lower part of the module, fully insert the module fixing projection(s) into the hole(s) in the base unit and press the module until it snaps into place.
Incorrect interconnection may cause malfunction, failure, or drop of the module.
When using the programmable controller in an environment of frequent vibrations, fix the module with a screw.
Tighten the screws within the specified torque range.
Undertightening can cause drop of the screw, short circuit, or malfunction.
Overtightening can damage the screw and/or module, resulting in drop, short circuit, or malfunction.
- When using an extension cable, connect it to the extension cable connector of the base unit securely.
Check the connection for looseness.
Poor contact may cause incorrect input or output.
- Shut off the external power supply (all phases) used in the system before cleaning the module.
Failure to do so may result in damage to the product.
A module can be replaced online (while power is on) on any MELSECNET/H remote I/O station or in the system where a CPU module supporting the online module change function is used.
Note that there are restrictions on the modules that can be replaced online, and each module has its predetermined replacement procedure.
For details, refer to the QCPU User's Manual (Hardware Design, Maintenance and Inspection) and the online module change in the manual for the module corresponding the online module change.
- Do not directly touch any conductive parts of the module.
Doing so can cause malfunction or failure of the module.

[Wiring Precautions]

WARNING

- Shut off the external power supply (all phases) used in the system before wiring.
Failure to do so may result in electric shock or damage to the product.
- After wiring, attach the included terminal cover to the module before turning it on for operation.
Failure to do so may result in electric shock.

[Wiring Precautions]

CAUTION

- Individually ground the FG terminal of the programmable controller with a ground resistance of 100Ω or less. Failure to do so may result in electric shock or malfunction.
- Check the rated voltage and terminal layout before wiring to the module, and connect the cables correctly.
Connecting a power supply with a different voltage rating or incorrect wiring may cause a fire or failure.
- Connectors for external devices must be crimped or pressed with the tool specified by the manufacturer, or must be correctly soldered.
Incomplete connections may cause short circuit, fire, or malfunction.
- Tighten the screws within the specified torque range.
Undertightening can cause short circuit, fire, or malfunction.
Overtightening can damage the screw and/or module, resulting in drop, short circuit, or malfunction.
- Tighten any unused terminal screws within the specified torque range (42 to 50N•cm).
Failure to do so may cause a short circuit due to contact with a solderless terminal.
- Use applicable solderless terminals and tighten them within the specified torque range.
If any spade solderless terminal is used, it may be disconnected when a terminal screw comes loose, resulting in failure.
- Prevent foreign matter such as dust or wire chips from entering the module.
Such foreign matter can cause a fire, failure, or malfunction.
- A protective film is attached to the top of the module to prevent foreign matter, such as wire chips, from entering the module during wiring.
Do not remove the film during wiring.
Remove it for heat dissipation before system operation.
- Place the cables in a duct or clamp them.
If not, dangling cable may swing or inadvertently be pulled, resulting in damage to the module or cables or malfunction due to poor contact.
- Do not install the control lines together with the communication cables.
Failure to do so may result in malfunction due to noise.
- When disconnecting the communication cable or power cable from the module, do not pull the cable by the cable part.
For the cable with connector, hold the connector part of the cable. Loosen the screws of a cable without a connector before disconnecting the cable. Failure to do so may result in damage to the module or cable or malfunction due to poor contact.

[Startup and Maintenance Precautions]

WARNING

- Do not touch any terminal or connector while power is on.
Failure to do so may result in electric shock.
- Shut off the external power supply (all phases) used in the system before cleaning the module or retightening the terminal screws or module fixing screws.
Failure to do so may result in electric shock.
Undertightening can cause drop of the screw, short circuit, or malfunction.
Overtightening can damage the screw and/or module, resulting in drop, short circuit, or malfunction.

CAUTION

- Before performing online operations (especially, program modification, forced output, and operating status change) for the running CPU module from the peripheral device connected, read relevant manuals carefully and ensure the safety.
Improper operation may damage machines or cause accidents.
- Do not disassemble or modify the module.
Doing so may cause failure, malfunction, injury, or a fire.
- Use any radio communication device such as a cellular phone or PHS (Personal Handy-phone System) more than 25cm away in all directions from the programmable controller.
Failure to do so may cause malfunction.
- Do not drop or apply strong shock to the module.
Doing so may damage the module.
- Shut off the external power supply (all phases) used in the system before mounting or removing a module.
Failure to do so may cause the module to fail or malfunction.
- After the first use of the product, do not mount/remove the module to/from the base unit more than 50 times (IEC 61131-2 compliant) respectively.
Exceeding the limit may cause malfunction.
- Before handling the module, touch a conducting object such as a grounded metal to discharge the static electricity from the human body.
Failure to do so may cause the module to fail or malfunction.

[Disposal Precautions]

CAUTION

- When disposing of this product, treat it as industrial waste.

● CONDITIONS OF USE FOR THE PRODUCT ●

- (1) Mitsubishi programmable controller ("the PRODUCT") shall be used in conditions;
- i) where any problem, fault or failure occurring in the PRODUCT, if any, shall not lead to any major or serious accident; and
 - ii) where the backup and fail-safe function are systematically or automatically provided outside of the PRODUCT for the case of any problem, fault or failure occurring in the PRODUCT.

- (2) The PRODUCT has been designed and manufactured for the purpose of being used in general industries.

MITSUBISHI SHALL HAVE NO RESPONSIBILITY OR LIABILITY (INCLUDING, BUT NOT LIMITED TO ANY AND ALL RESPONSIBILITY OR LIABILITY BASED ON CONTRACT, WARRANTY, TORT, PRODUCT LIABILITY) FOR ANY INJURY OR DEATH TO PERSONS OR LOSS OR DAMAGE TO PROPERTY CAUSED BY the PRODUCT THAT ARE OPERATED OR USED IN APPLICATION NOT INTENDED OR EXCLUDED BY INSTRUCTIONS, PRECAUTIONS, OR WARNING CONTAINED IN MITSUBISHI'S USER, INSTRUCTION AND/OR SAFETY MANUALS, TECHNICAL BULLETINS AND GUIDELINES FOR the PRODUCT.

("Prohibited Application")

Prohibited Applications include, but not limited to, the use of the PRODUCT in;

- Nuclear Power Plants and any other power plants operated by Power companies, and/or any other cases in which the public could be affected if any problem or fault occurs in the PRODUCT.
- Railway companies or Public service purposes, and/or any other cases in which establishment of a special quality assurance system is required by the Purchaser or End User.
- Aircraft or Aerospace, Medical applications, Train equipment, transport equipment such as Elevator and Escalator, Incineration and Fuel devices, Vehicles, Manned transportation, Equipment for Recreation and Amusement, and Safety devices, handling of Nuclear or Hazardous Materials or Chemicals, Mining and Drilling, and/or other applications where there is a significant risk of injury to the public or property.

Notwithstanding the above, restrictions Mitsubishi may in its sole discretion, authorize use of the PRODUCT in one or more of the Prohibited Applications, provided that the usage of the PRODUCT is limited only for the specific applications agreed to by Mitsubishi and provided further that no special quality assurance or fail-safe, redundant or other safety features which exceed the general specifications of the PRODUCTS are required. For details, please contact the Mitsubishi representative in your region.

REVISIONS

* The handbook number is given on the bottom left of the back cover.

Print Date	* Handbook Number	Revision
January, 2013	L(NA)08263ENG-A	First edition
May, 2015	L(NA)08263ENG-B	<p>[Change]</p> <p>Chapter 7 to Appendix 1, Appendix1 to Appendix 2</p> <p>[Partial correction]</p> <p>SAFETY PRECAUTIONS,GENERIC TERMS AND ABBREVIATIONS</p>

Japanese Handbook Version L08249-A

This handbook confers no industrial property rights or any rights of any other kind, nor does it confer any patent licenses. Mitsubishi Electric Corporation cannot be held responsible for any problems involving industrial property rights which may occur as a result of using the contents noted in this handbook.

© 2013 MITSUBISHI ELECTRIC CORPORATION

CONTENTS

SAFETY PRECAUTIONS	A - 1
CONDITIONS OF USE FOR THE PRODUCT	A - 7
REVISIONS	A - 8
CONTENTS	A - 9
GENERIC TERMS AND ABBREVIATIONS	A - 12

CHAPTER 1 INTRODUCTION **1 - 1 to 1 - 2**

1.1 Replacement with AnyWire DB A20	1 - 1
1.2 Precautions for Replacement	1 - 2
1.3 Features of AnyWire DB A20	1 - 2

CHAPTER 2 PERFORMANCE SPECIFICATIONS COMPARISONS **2 - 1 to 2 - 4**

2.1 Performance Specifications Comparison of MELSEC-I/OLINK and AnyWire DB A20	2 - 1
2.2 Wiring for AnyWire DB A20	2 - 3
2.2.1 Transmission distance	2 - 3
2.2.2 Terminator connection	2 - 3
2.2.3 Branch of transmission lines (transmission distance: 1km)	2 - 4

CHAPTER 3 FUNCTIONAL COMPARISONS **3 - 1 to 3 - 3**

3.1 Functional Comparisons of MELSEC-I/OLINK and AnyWire DB A20	3 - 1
3.2 Master Module Switch Comparisons	3 - 2

CHAPTER 4 REPLACING THE MASTER MODULE **4 - 1 to 4 - 2**

4.1 List of Alternative Master Module Models	4 - 1
--	-------

CHAPTER 5 PROGRAMS COMPARISONS **5 - 1 to 5 - 6**

5.1 I/O Signals	5 - 1
5.1.1 MELSEC-I/OLINK	5 - 1
5.1.2 AnyWire DB A20 (QJ51AW12D2)	5 - 3

CHAPTER 6 REPLACING THE I/O MODULES **6 - 1 to 6 - 40**

6.1 List of Alternative I/O Module Models	6 - 1
6.2 I/O Module Specifications Comparisons	6 - 6
6.2.1 Input module specifications comparisons	6 - 6
6.2.2 Output module specifications	6 - 12
6.2.3 I/O module specifications comparisons	6 - 18
6.3 Applicable Crimping Terminal	6 - 40

APPENDICES**APPX- 1 to APPX - 2**

Appendix 1 External Dimensions	APPX - 1
Appendix 2 Relevant Manuals	APPX - 2
Appendix 2.1 Replacement handbooks	APPX - 2
Appendix 2.2 MELSEC-I/OLINK	APPX - 2
Appendix 2.3 AnyWire DB A20	APPX - 2

- For the products shown in handbooks for transition, catalogues, and transition examples, refer to the manuals for the relevant products and check the detailed specifications, precautions for use, and restrictions before replacement.

For the products manufactured by Mitsubishi Electric Engineering Co., Ltd., Mitsubishi Electric System & Service Co., Ltd., and other companies, refer to the catalogue for each product and check the detailed specifications, precautions for use, and restrictions before use.

The manuals and catalogues for our products, products manufactured by Mitsubishi Electric Engineering Co., Ltd., and Mitsubishi Electric System & Service Co., Ltd. are shown in Appendix of each handbook for transition.

- Products shown in this handbook are subject to change without notice.

GENERIC TERMS AND ABBREVIATIONS

Unless otherwise specified, this handbook uses the following generic terms and abbreviations.

Generic term/abbreviation	Description
■Series	
A series	The abbreviation for large types of Mitsubishi MELSEC-A series programmable controllers
AnS series	The abbreviation for compact types of Mitsubishi MELSEC-A series programmable controllers
A/AnS series	A generic term for A series and AnS series
QnA series	The abbreviation for large types of Mitsubishi MELSEC-QnA series programmable controllers
QnAS series	The abbreviation for compact types of Mitsubishi MELSEC-QnA series programmable controllers
QnA/QnAS series	A generic term for QnA series and QnAS series
A/AnS/QnA/QnAS series	A generic term for A series, AnS series, QnA series, and QnAS series
Q series	The abbreviation for Mitsubishi MELSEC-Q series programmable controllers
L series	The abbreviation for Mitsubishi MELSEC-L series programmable controllers
■CPU module type	
CPU module	A generic term for A series, AnS series, QnA series, QnAS series, Q series, and L series CPU modules
Basic model QCPU	A generic term for the Q00JCPU, Q00CPU, and Q01CPU
High Performance model QCPU	A generic term for the Q02CPU, Q02HCPU, Q06HCPU, Q12HCPU, and Q25HCPU
Process CPU	A generic term for the Q02PHCPU, Q06PHCPU, Q12PHCPU, and Q25PHCPU
Redundant CPU	A generic term for the Q12PRHCPU and Q25PRHCPU
Universal model QCPU	Generic term for the Q00UJCPU, Q00UCPU, Q01UCPU, Q02UCPU, Q03UDCPU, Q03UDVCPU, Q03UDECPU, Q04UDHCPU, Q04UDVCPU, Q04UDEHCPU, Q06UDHCPU, Q06UDVCPU, Q06UDEHCPU, Q10UDHCPU, Q10UDEHCPU, Q13UDHCPU, Q13UDVCPU, Q13UDEHCPU, Q20UDHCPU, Q20UDEHCPU, Q26UDHCPU, Q26UDVCPU, Q26UDEHCPU, Q50UDEHCPU, and Q100UDEHCPU
■CPU module model	
ACPU	A generic term for MELSEC-A series CPU modules
AnSCPU	A generic term for MELSEC-AnS series CPU modules
AnNCP	A generic term for the A1NCP, A1NCPUP21/R21, A1NCPUP21-S3, A2NCP, A2NCP-S1, A2NCPUP21/R21, A2NCPUP21/R21-S1, A2NCPUP21-S3(S4), A3NCP, A3NCPUP21/R21, and A3NCPUP21-S3
AnACPU	A generic term for the A2ACPU, A2ACPU-S1, A3ACPU, A2ACPUP21/R21, A2ACPUP21/R21-S1, and A3ACPUP21/R21
AnUCPU	A generic term for the A2UCPU, A2UCPU-S1, A3UCPU, and A4UCPU
AnUS(H)CPU	A generic term for the A2USCPU, A2USCPU-S1, A2USHCPU-S1
A/AnSCPU	A generic term for MELSEC-A series and -AnS series CPU modules
AnN/AnACPU	A generic term for the AnNCP and AnACPU
AnN/AnA/AnSCPU	A generic term for the AnNCP, AnACPU, and AnSCPU
QnACPU	A generic term for MELSEC-QnA series CPU modules
QnASCPU	A generic term for MELSEC-QnAS series CPU modules
QnA/QnASCPU	A generic term for MELSEC-QnA series and -QnAS series CPU modules
A/AnS/QnA/QnASCPU	A generic term for MELSEC-A series, -AnS series, -QnA series, and -QnAS series CPU modules
QCPU	A generic term for MELSEC-Q series CPU modules
LCPU	A generic term for MELSEC-L series CPU modules

1 INTRODUCTION

1.1 Replacement with AnyWire DB A20

The MELSEC-Q and L series do not have an MELSEC-I/OLINK master module. Therefore, the alternatives are the AnyWire DB A20 and the CC-Link/LT. Features for replacement are listed in the following table.

Replacing MELSEC-I/OLINK with AnyWire DB A20 or CC-Link/LT

○ : Compatible, × : Not compatible

Item	Replacement with AnyWire DB A20 (MELSEC-Q series)		Replacement with CC-Link/LT (MELSEC-Q/L series)	
	Compati- bility	Description	Compati- bility	Description
External power supply	○	The existing I/OLINK external power supply can be used.	×	A power supply adapter is necessary.
Connection type	○	T-branch system, or tree branch system	○	T-branch system
Connection cable	○	The existing I/OLINK cables can be used.	×	New cables must be installed.
I/O module type	○	4, 8, or 16 points Input module/Output module/I/O combined module	○	2, 4, or 8 points Input module/Output module/I/O combined module
Programming	×	The master module occupies 32 points. The I/O module address becomes the specified device by the FROM/TO instruction.	○	XY address of the master module becomes XY address of the I/O module. Needless to change address (up to 64 points)

☒ Point

AnyWire products are not available in some countries. For details, please consult your local Mitsubishi representative.

This transition handbook explains replacement of the MELSEC-I/OLINK with the AnyWire DB A20.

For replacement with the CC-Link/LT, refer to the following transition handbook.

Transition from MELSEC-I/OLINK to CC-Link/LT Handbook



1.2 Precautions for Replacement

- (1) Before replacing MELSEC-I/OLINK with AnyWire DB A20, refer to the manuals for each AnyWire DB A20 module, and check the functions, specifications, and how to use the modules.
- (2) After replacing MELSEC-I/OLINK with AnyWire DB A20, check the operation of the entire system before starting the actual operation.

1.3 Features of AnyWire DB A20

The transmission distance can be selected from 50m, 200m, 1km, and 3km using the dip switch. Up to 512 remote input points and 512 remote output points can be controlled by one QJ51AW12D2 (in the standard setting).

Disconnections can be detected even when the wiring is branched.

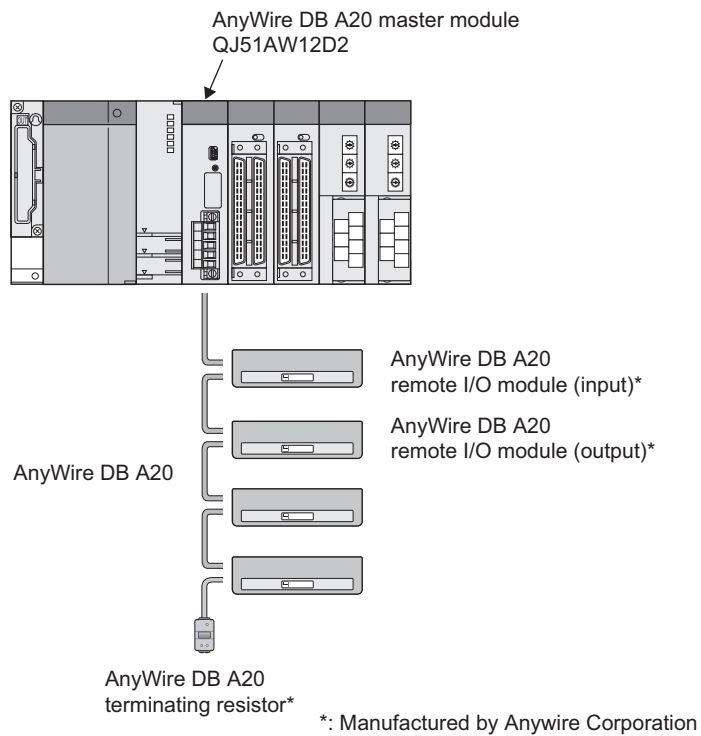

2 PERFORMANCE SPECIFICATIONS COMPARISONS

2.1 Performance Specifications Comparison of MELSEC-I/OLINK and AnyWire DB A20

○ : Compatible, △ : Partially changed, × : Not compatible

Item		Specifications		Com- pati- bility	Precautions for replace- ment
		MELSEC-I/OLINK	AnyWire DB A20		
Per single master station	Max. number of link stations	16 stations (1 station 4 points)	128 stations	○	
	Max. number of control I/O points	128 points (when the same number is used on X and Y)	1024 points (when the same number is used on X and Y)	○	
Link scan time		Approx. 5.4ms	2.7ms (for 128 points) ^{*1}	○	
Overall distance		200m	125kHz: 50m 31.3kHz: 200m 7.8kHz: 1km 2kHz: 3km	○	1kHz is equivalent to 1kbps.
Communication speed		38.4kbps	125kHz/31.3kHz/7.8kHz/2kHz	△	Select the speed based on the existing overall distance. 1kHz is equivalent to 1kbps.
Error control method		Parity check	Double-check system	△	The error control method is different, but an error check function is provided.
Network Topology		Bus (T-branch available)	Bus (Multidrop system, T-branch system, star system, or tree system)	○	
Connection cable		Twisted pair cable (0.75mm ²), Cabtire cable (0.75mm ²)	General-purpose 2-/4-wire cable (VCTF, VCF 0.75 to 1.25mm ²), General-purpose wire (0.75 to 1.25mm ²), Dedicated flat cable (0.75mm ²), (When the transmission distance exceeds 200m, use wires with a diameter of 0.9 to 1.25mm ² .)	○	Crimping terminals can be used. However, the communication lines and power lines connected to the master module must be processed to connect to terminals.
Terminating resistor (terminator)		Not required	Required	×	A terminating resistor is necessary.
External power supply to master module	Voltage	21.6 to 27.6VDC	24VDC +15 to -10% (21.6 to 27.6VDC) Ripple voltage 0.5Vp-p or less	△	Because the external power supply current has increased, the current capacity must be reviewed.
	Current	0.09A	0.5A (When 128 slave modules are connected and the load current is not included)		
Number of occupied I/O points of master module		16, 32, 48, or 64 points	32 points	△	The program and parameters must be changed.
Internal current consumption of master module		0.115A	0.5A	△	Internal current consumption of 5VDC must be recalculated.

*1 The transmission cycle time of AnyWire DB A20 (QJ51AW12D2) differs by the number of transmission points setting or the transmission clock. For details, refer to the following table.

Max. number of transmission points setting	Transmission cycle time (ms)			
	125kHz	31.3kHz	7.8kHz	2kHz
	(50m)	(200m)	(1km)	(3km)
64 points (32 points × 2)	0.42	1.7	6.8	24.8
128 points (64 points × 2)	0.7	2.7	10.9	40.7
256 points (128 points × 2)	1.2	4.8	19.1	72.4
384 points (192 points × 2)	1.7	6.8	27.3	104.2
512 points (256 points × 2)	2.2	8.9	35.5	135.9
640 points (320 points × 2)	2.7	10.9	43.6	167.6
768 points (384 points × 2)	3.2	13.0	51.8	199.4
896 points (448 points × 2)	3.8	15.0	60.0	231.1
1024 points (512 points × 2)	4.3	17.1	68.2	262.9
2048 points (1024 points × 2)	8.4	33.4	133.8	516.8

2.2 Wiring for AnyWire DB A20

2.2.1 Transmission distance

Item	Specifications			
Transmission clock	125kHz ^{*1}	31.3kHz	7.8kHz	2kHz
Max. transmission distance (total length)	50m	200m	1km	3km
Number of connectable modules	Up to 128	Up to 128	Up to 128	Up to 32 ^{*2}

*1 When the transmission clock is set to 125 kHz, use the product under the following conditions.

- External power supply voltage range: 21.6VDC to 25.2VDC
- Operating ambient temperature: 0 to 50°C

*2 Up to 64 modules can be connected within 2km.

2.2.2 Terminator connection

To ensure more stable transmission, connect the terminating resistor (AT2 manufactured by Anywire Corporation) at the end of the transmission line.

■ Terminating unit

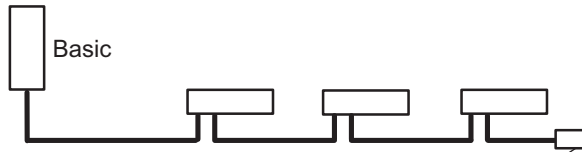

Important

Connect a terminating unit at the end of a line for one master module.

- | | |
|-----------------------|---------------------|
| Transmission distance | 50m (total length) |
| | 200m (total length) |
| | 1km (total length) |
| | 3km (total length) |

The setting applies to all the transmission speeds.

2.2.3 Branch of transmission lines (transmission distance: 1km)

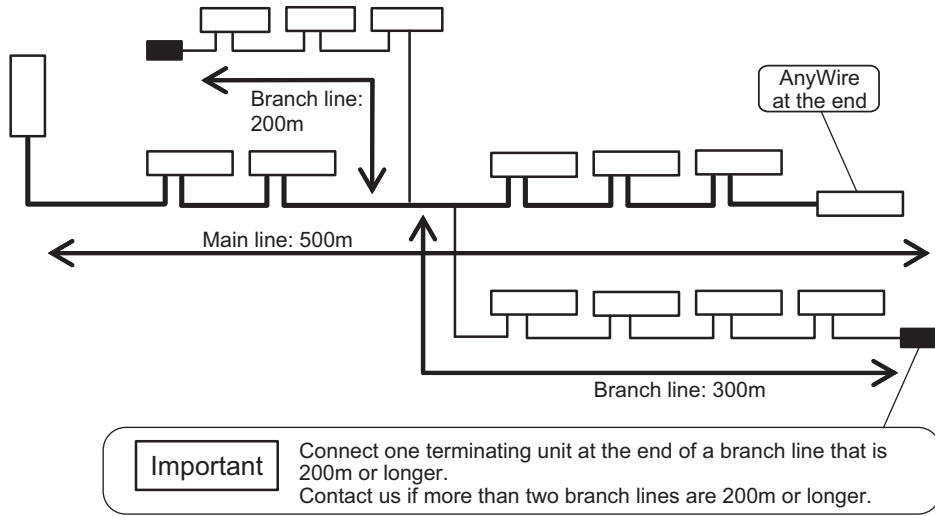

■ Total length

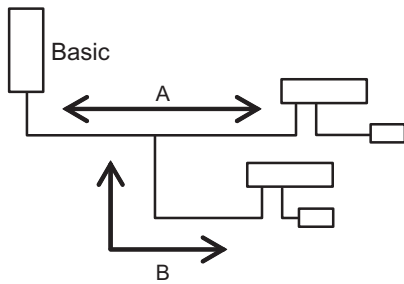

The total length of the transmission distance for the AnyWire DB A20 can be calculated from $A + B$. Note that the total length should not exceed the maximum transmission distance set for the system to branch lines.

3 FUNCTIONAL COMPARISONS

3.1 Functional Comparisons of MELSEC-I/OLINK and AnyWire DB A20

○ : Compatible, △ : Partially changed, × : Not compatible

Item	Specifications		Compat- ibility	Precautions for replacement
	MELSEC-I/OLINK	AnyWire DB A20		
Remote station communication	Communication with up to 16 slave stations is possible.	Communication with up to 128 slave stations is possible.	○	
Remote station address	XY address of the master station becomes the XY address of the remote station module.	I/O information is stored in the buffer memory. The device that data are read from and written to the buffer memory by the FROM/TO instruction will be assigned to the remote station module address in the program.	×	Program change or different remote station module line numbers are required because the concept of the addresses is different.
RAS function	Detection of faulty station (display)	The LED display (ERROR STATION) on the master station notifies a user of faulty stations.	○	
	Notification method of the error detection to the CPU module	When an error is detected, the CPU module is notified by Fuse blown detection (M 9000). External output is also performed from the RUN A/B terminals on the MELSEC-I/OLINK master module.	△	Change of the sequence program is required because the notifying device differs. If an external output is required, an output signal is necessary.
	Line check	Cable disconnection can be checked by the ON status of the LEDs on the master station and slave stations.	○	
Others	Error check of disconnected station enabled/disabled setting	If there is a station that is not connected, the error check can be disabled by setting the ON LINE STATION switch of the master station to off.	○	Though the setting method differs, a station that is not connected can be detected.

3.2 Master Module Switch Comparisons

○ : Compatible, △ : Partially changed, × : Not compatible

Item	Specifications		Compat- ibility	Precautions for replacement
	MELSEC-I/OLINK	AnyWire DB A20		
Number of transmission points setting (I/OLINK)	The number of occupied points of the master module is set to 16, 32, 48, or 64 points by the I/O assignment of the parameter. The number of occupied points of the master module becomes the maximum number of connected points. Set by parameters and there is no switch setting.	The number of transmission points of the slave module is set by the intelligent function switch setting of PLC Parameter in GX Developer.*1	△	The maximum number of transmission points setting method is changed from setting the I/O assignment of parameter to intelligent function switch setting.
Operation mode selector (AnyWire DB A20)	Setting is not required, because the communication speed and transmission distance are fixed.	Select the transmission distance. The transmission clock is determined by the transmission distance setting.	△	Settings are required in accordance with the number of connected slave modules and the overall distance.
ON LINE STATION (I/OLINK)	A switch for determining use/not use of remote I/O module.	–	△	Though the setting method differs, the station to be used (remote I/O module or slave module) can be determined.
SET switch (AnyWire DB A20)	–	A switch to let the master module automatically recognize the ID (address) of the slave module.		

*1 Switch setting of the QJ51AW12D2 is performed by using PLC Parameter setting in GX Developer.

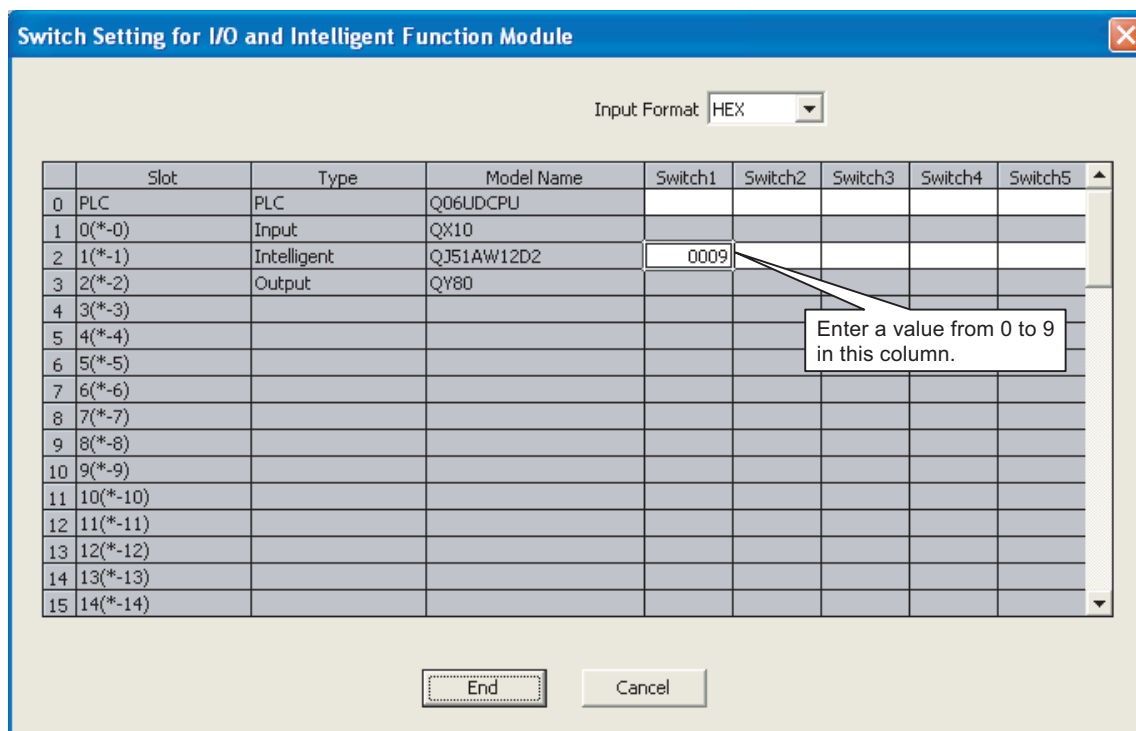

- Value from 0 to 9 set for "Switch 1" and the number of connected I/O points

Number of connected I/O points		Switch 1
Input	Output	
512	512	0
448	448	1
384	384	2
320	320	3
256	256	4
192	192	5
128	128	6
64	64	7
32	32	8
1024	1024	9 ^{*1}

A to F of "Switch 1" are reserved by the system. Do not change the settings.

*1 Use the value as necessary.

Transmission is also possible for normal use. However, the address after the "Maximum address setting to Number of self occupied points" of the slave module for the AnyWire DB A20 becomes empty, and the transmission cycle time becomes slower.

Ex.

For 32-point remote I/O module

- Maximum address setting: 510
- Number of self occupied points: 32 points

According to the above, 510 to 541 points are used as the maximum address that is occupied by the remote I/O module. Addresses of 541 to 1023 points become empty, and cannot be assigned.

☒ Point

If the switch setting is changed using a programming tool, write the parameters and supply the power again or reset the system.

Without these operations, transmission points are not set.

4 REPLACING THE MASTER MODULE

4.1 List of Alternative Master Module Models

MELSEC-I/OLINK		Alternative model for AnyWire DB A20	
Product	Model	Model	Remarks (restrictions)
Master module	AJ51T64 A1SJ51T64	QJ51AW12D2	It is recommended to replace the module with the AnyWire DB A20. For details, refer to the user's manual for each module.

5 PROGRAMS COMPARISONS

5.1 I/O Signals

5.1.1 MELSEC-I/OLINK

I/O signals of the MELSEC-I/OLINK will be assigned to the addresses of the connected remote I/O module.

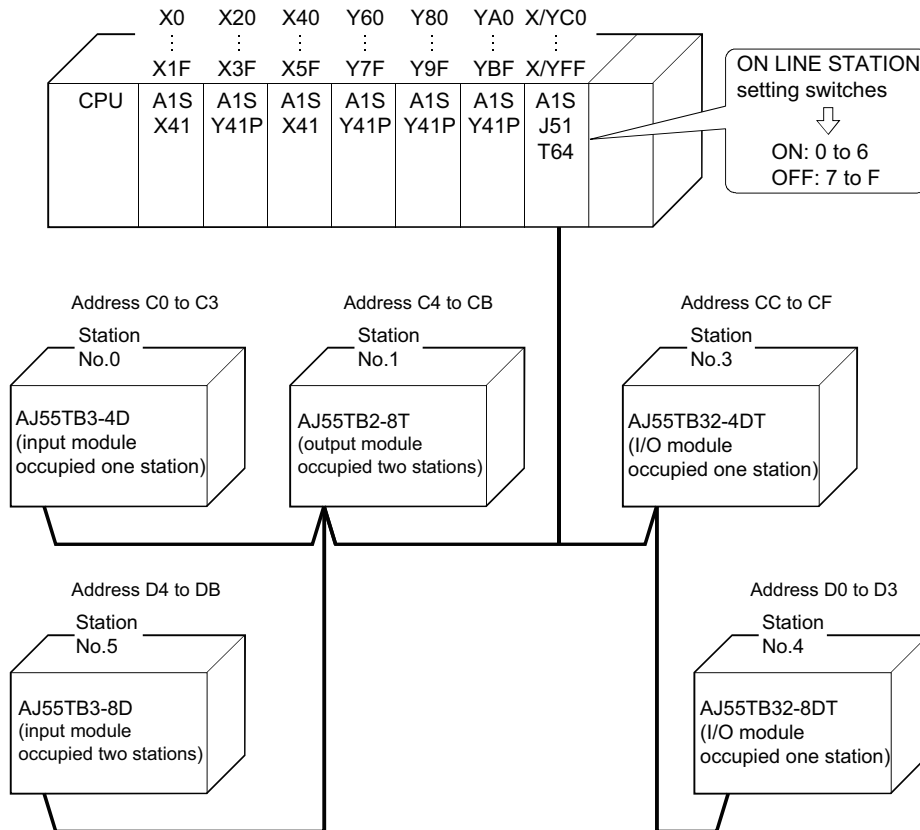

The following table listed addresses for each remote I/O module.

Station No. of remote I/O module	Addresses (Hexadecimal)	Device		Remarks
		X	Y	
0	C0	■		AJ55TB3-4D (input 4-point module)
	1	■		
	2	■		
	3	■		
1	4		■	AJ55TB2-8T (output 8-point module)
	5		■	
	6		■	
	7		■	
2	8		■	AJ55TB32-4DT (input 2-point/output 2-point module) (A 4-point I/O combined module can be used the first half 2 points of both of X and Y. The module cannot be used the second half 2 points.
	9		■	
	A		■	
	B		■	
3	C	■	■	AJ55TB32-8DT (input 4-point/output 4-point module)
	D	■	■	
	E			
	F			
4	D0	■	■	AJ55TB3-8D (input 8-point module)
	1	■	■	
	2	■	■	
	3	■	■	
5	4	■		AJ55TB3-8D (input 8-point module)
	5	■		
	6	■		
	7	■		
6	8	■		
	9	■		
	A	■		
	B	■		
	C			

The device used is indicated by ■.

5.1.2 AnyWire DB A20 (QJ51AW12D2)

Details on the addresses when replacing the I/OLINK are explained by using the module configuration example described in Section 5.1.1.

☒ Point

I/O information of the AnyWire DB A20 are stored in the buffer memory. The device that data are read from and written to the buffer memory by the FROM/TO instruction will be assigned to the remote station module address in the program. The program that controls input and output of the I/OLINK remote station must be changed.

[System configuration example]

In this example, settings are made to match the addresses of the existing I/OLINK. Since the number of occupied points differ between the existing module and the replacement module, their addresses cannot be assigned in the same way. The addresses in this replacement module is example. They can be assigned as desired according to the system configuration.

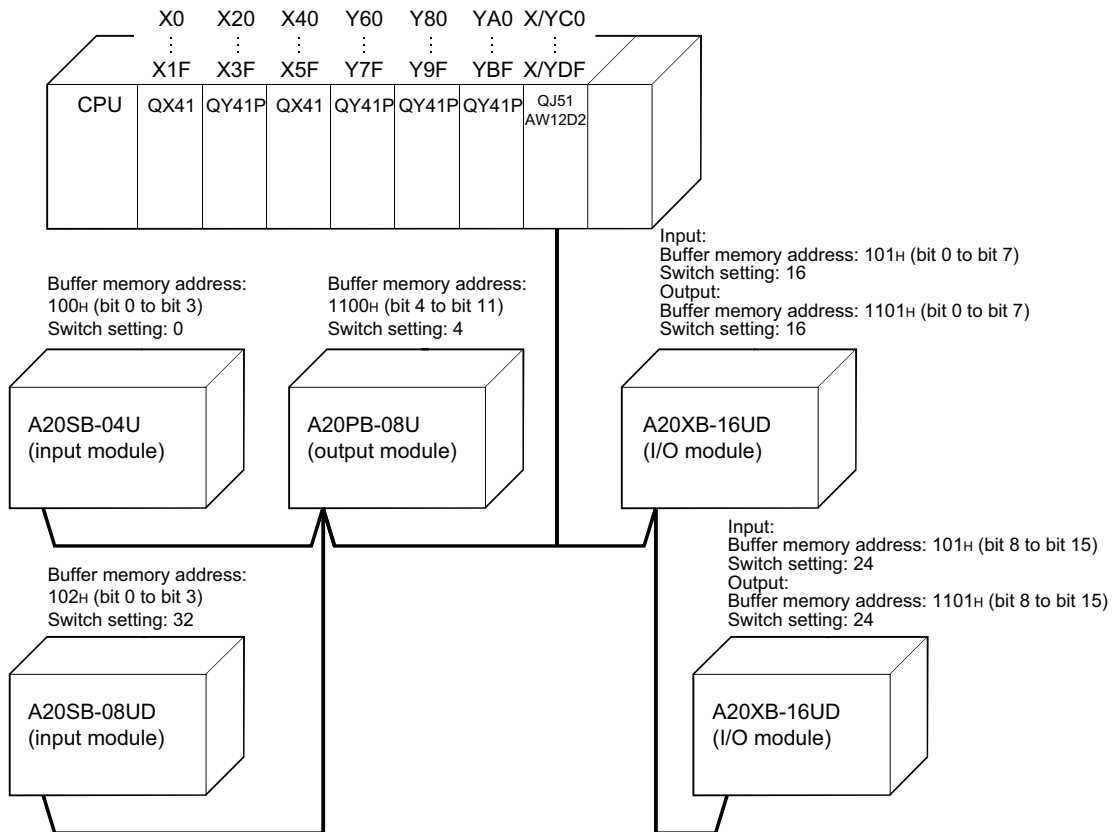

Existing module	Existing address (Refer to configuration in Section 5.1.1.)	Replaced module	Input side address		Output side address	
			Switch setting	Buffer memory address	Switch setting	Buffer memory address
AJ55TB3-4D (input 4 points)	XC0 to XC3	A20SB-04U (input 4 points)	0	100 _H bit 0 to bit 3	-	
AJ55TB2-8T (input 8 points)	XC4 to XCB	A20PB-08U (input 8 points)	-		4	1100 _H bit 4 to bit 11
AJ55TB32-4DT (input 2 points/output 2 points) Number of occupied points is 4.	XCC to XCD (XCC to XCF are occupied.)	A20XB-16UD (input 8 points/output 8 points)	16	101 _H bit 0 to bit 7	-	
	YCC to YCD (YCC to YCF are occupied.)		-		16	1101 _H bit 0 to bit 7
AJ55TB32-8DT (input 4 points/output 4 points) Number of occupied points is 4.	XD0 to XD3	A20XB-16UD (input 8 points/output 8 points)	24	101 _H bit 8 to bit 15	-	
	YD0 to YD3 (YCC to YCF are occupied.)		-		24	1101 _H bit 8 to bit 15
AJ55TB3-8D (input 8 points)	XD4 to XDB	A20SB-08UD (input 4 points)	32	102 _H bit 0 to bit 7	-	

Bit 15	Bit 14	Bit 13	Bit 12	Bit 11	Bit 10	Bit 9	Bit 8	Bit 7	Bit 6	Bit 5	Bit 4	Bit 3	Bit 2	Bit 1	Bit 0
--------	--------	--------	--------	--------	--------	-------	-------	-------	-------	-------	-------	-------	-------	-------	-------

Unused due to fractional points	Unused (used area for the existing output module AJ55TB2-8T)	A20SB-04U (replacement area for AJ55TB3-4D) (input: 4 points)	Buffer memory address
A20XB-16UD (replacement area for AJ55TB32-8DT) (input: 8 points)	A20XB-16UD (replacement area for AJ55TB32-4DT) (input: 8 points)		100 _H
Unused	A20XB-08UD (replacement area for AJ55TB32-8D) (input: 8 points)		101 _H
			102 _H

Unused due to fractional points	A20PB-08U (replacement area for AJ55TB2-8T) (output: 8 points)	Unused (used area for the existing input module AJ55TB3-4D)	Buffer memory address
A20XB-16UD (replacement area for AJ55TB32-8DT) (output: 8 points)	A20XB-16UD (replacement area for AJ55TB32-4DT) (output: 8 points)		1100 _H
Unused	Unused (used area for the existing input module AJ55TB32-8D)		1101 _H
			1102 _H

* The XY address specified by the buffer memory read/write instruction "FROM/TO" becomes the XY address in the program. The following shows the XY address of each module when the FROM/TO instruction is programmed.

FROM TO	H0C H0C	H100 H100	K4X1000 K4Y1000	K3 K3	Buffer memory address
Unused due to fractional points	Unused (used area for the existing output module AJ55TB2-8T)		A20SB-04U (input: 4 points) X1000 to X1003		100H
A20XB-16UD (input: 8 points) X1018 to X101F		A20XB-16UD (input: 8 points) X1010 to X1017			101H
Unused		A20XB-08UD (input: 8 points) X1020 to X1027			102H
Unused due to fractional points	A20PB-08U (output: 8 points) Y1004 to Y101B		Unused (used area for the existing input module AJ55TB3-40)		1100H
A20XB-16UD (output: 8 points) Y1018 to Y101F		A20XB-16UD (output: 8 points) Y1010 to Y1017			1101H
Unused		Unused (used area for the existing input module AJ55TB32-8D)			1102H

Remarks

- (1) I/O signals of the AnyWire DB A20 (QJ51AW12D2)
I/O signals of the QJ51AW12D2 indicate the state of the module, and are used as command output. This is different from using as ON/OFF signals of the remote station for MELSEC-I/OLINK. The "n" in the table is the start I/O number of the QJ51AW12D2 which is determined according to the mounted position and modules mounted before the QJ51AW12D2.

Ex. If the start I/O number of the QJ51AW12D2 is "X/Y10"

Xn0 to X(n+1)F → X10 to X2F

Yn0 to X(n+1)F → Y10 to Y2F

Input number	Signal name	Output number	Signal name
Xn0	Module READY	Yn0	Disconnection flag reset command output
Xn1	Short between D and G terminals	Yn1	Automatic address detection command output
Xn2	Short between D and 24V terminals	Yn2 to YnF	Use prohibited
Xn3	24V not applied		
Xn4	D/G line disconnection		
Xn5 to Xn7	Use prohibited		
Xn8 to XnB	"Switch Setting for I/O and Intelligent Function Module" Switch 1 setting value*		
XnC to XnF	Use prohibited		
X(n+1)0 to X(n+1)F	Use prohibited	Y(n+1)0 to Y(n+1)F	Use prohibited

* When 8 is set for "Switch 1", the settings are as follows.
Xn8: OFF, Xn9: OFF, XnA: OFF, XnB: ON

(2) Buffer memory of the AnyWire DB A20 (QJ51AW12D2)

In the MELSEC-I/OLINK, the occupied XY address of the master module becomes the XY address of the remote station module, while in the AnyWire DB A20 (QJ51AW12D2) the ON/OFF information of a slave module is stored in the buffer memory. Therefore, the address of the slave module in the program will be the device or the device number used the FROM/TO instruction which data are read from and written to the buffer memory.

This area is for data communication between the AnyWire master station (QJ51AW12D2) and CPU module.

Buffer memory address	Description
100 _H to 13F _H	Input (1024 points): The lowest bit of 100 _H is the 0th data, and the highest bit of 13F _H is the 1023rd data.
1100 _H to 113F _H	Output (1024 points): The lowest bit of 1100 _H is the 0th data, and the highest bit of 113F _H is the 1023rd data.
2000 _H	Number of error IDs (1 word)
2001 _H to 2080 _H	Error ID information

Ex. Correspondence between the buffer memory address and AnyWire DB A20 input address

Buffer memory address	Bit	No.														
	15	14	13	12	11	10	9	8	7	6	5	4	3	2	1	0
100 _H	15	14	13	12	11	10	9	8	7	6	5	4	3	2	1	0
101 _H	31	30	29	28	27	26	25	24	23	22	21	20	19	18	17	16

AnyWire input address: 0

For details, refer to the following manual.

MELSEC-Q AnyWire DB A20 Master Module User's Manual SH(NA)-080968ENG



6 REPLACING THE I/O MODULES

6.1 List of Alternative I/O Module Models

I/OLINK series model		AnyWire DB A20 series alternative model	
Product	Model name	Model name	Remarks (restrictions)
Input module	AJ55TB3-4D (when positive common type is used)	A20SB-04U	(1) External wiring: Changed (2) Number of modules: Not changed (3) Program: Changed (4) Specifications: Rated input voltage: Not changed Rated input current: Not changed ON voltage/ON current: Changed OFF voltage/OFF current: Changed Input resistance: Not changed (5) Functions: Changed (wiring: 3-wire → 2-wire) (A negative common type cannot be used.)
	AJ55TB3-4D (when negative common type is used)	A20SB-04US	(1) External wiring: Changed (2) Number of modules: Not changed (3) Program: Changed (4) Specifications: Rated input voltage: Not changed Rated input current: Not changed ON voltage/ON current: Changed OFF voltage/OFF current: Changed Input resistance: Not changed (5) Functions: Changed (wiring: 3-wire → 2-wire) (A positive common type cannot be used.)
	AJ55TB3-8D (when positive common type is used)	A20SB-08UD	(1) External wiring: Changed (2) Number of modules: Not changed (3) Program: Changed (4) Specifications: Rated input voltage: Not changed Rated input current: Not changed ON voltage/ON current: Changed OFF voltage/OFF current: Changed Input resistance: Not changed (5) Functions: Changed (A negative common type cannot be used.)
	AJ55TB3-8D (when negative common type is used)	A20SB-08USD-1	(1) External wiring: Changed (2) Number of modules: Not changed (3) Program: Changed (4) Specifications: Rated input voltage: Not changed Rated input current: Not changed ON voltage/ON current: Changed OFF voltage/OFF current: Changed Input resistance: Not changed (5) Functions: Changed (A positive common type cannot be used.)

I/OLINK series model		AnyWire DB A20 series alternative model	
Product	Model name	Model name	Remarks (restrictions)
Input module	AJ55TB3-16D (when positive common type is used)	A20SB-16UD	(1) External wiring: Changed (2) Number of modules: Not changed (3) Program: Changed (4) Specifications: Rated input voltage: Not changed Rated input current: Not changed ON voltage/ON current: Changed OFF voltage/OFF current: Changed Input resistance: Not changed (5) Functions: Changed (A negative common type cannot be used.)(8 points/common → 16 points/common)
	AJ55TB3-16D (when negative common type is used)	A20SB-16USD	(1) External wiring: Changed (2) Number of modules: Not changed (3) Program: Changed (4) Specifications: Rated input voltage: Not changed Rated input current: Not changed ON voltage/ON current: Changed OFF voltage/OFF current: Changed Input resistance: Not changed (5) Functions: Changed (A positive common type cannot be used.)(8 points/common → 16 points/common)
Output module	AJ55TB2-4R	A20PB-04RS	(1) External wiring: Changed (2) Number of modules: Not changed (3) Program: Changed (4) Specifications: Rated load voltage: Changed (The voltage that can be used is equivalent.) Rated load current: Not changed Maximum switching frequency: Changed (3600 times/hour → 20 times/minute) (5) Functions: Changed (4 points/common → All points independent)
	AJ55TB2-8R	A20PB-08RS	(1) External wiring: Changed (2) Number of modules: Not changed (3) Program: (4) Specifications: Rated load voltage: Changed (The voltage that can be used is equivalent.) Rated load current: Not changed Maximum switching frequency: Changed (3600 times/hour → 20 times/minute) (5) Functions: Changed (8 points/common → All points independent)
	AJ55TB2-16R	A20PB-16RS	(1) External wiring: Changed (2) Number of modules: Not changed (3) Program: Changed (4) Specifications: Rated load voltage: Changed (The voltage that can be used is equivalent.) Rated load current: Not changed Maximum switching frequency: Changed (3600 times/hour → 20 times/minute) (5) Functions: Changed (8 points/common → All points independent)
	AJ55TB2-4T	A20PB-04U	(1) External wiring: Changed (2) Number of modules: Not changed (3) Program: Changed (4) Specifications: Rated load voltage: Changed (12VDC is not applicable.) Rated load current: Changed (0.5A/point → 0.2A/point) (5) Functions: Changed (Surge suppressor: Supported → Not supported)
	AJ55TB2-8T	A20PB-08U	(1) External wiring: Changed (2) Number of modules: Not changed (3) Program: Changed (4) Specifications: Rated load voltage: Changed (12VDC is not applicable.) Rated load current: Changed (0.5A/point → 0.2A/point) (5) Functions: Changed (Surge suppressor: Supported → Not supported)
	AJ55TB2-16T	A20PB-16U	(1) External wiring: Changed (2) Number of modules: Not changed (3) Program: Changed (4) Specifications: Rated load voltage: Changed (12VDC is not applicable.) Rated load current: Changed (0.5A/point → 0.2A/point) (5) Functions: Changed (Surge suppressor: Supported → Not supported)

I/OLINK series model		AnyWire DB A20 series alternative model	
Product	Model name	Model name	Remarks (restrictions)
I/O module	AJ55TB32-4DR (when positive common type is used)	A20SB-04U + A20PB-04RS	(1) External wiring: Changed (2) Number of modules: Changed (Two modules are required.) (3) Program: Changed (4) Specifications: (Input part) Rated input voltage: Not changed Rated input current: Not changed ON voltage/ON current: Changed OFF voltage/OFF current: Changed Input resistance: Not changed (Output part) Rated load voltage: Changed (The voltage that can be used is equivalent.) Rated load current: Not changed Maximum switching frequency: Changed (3600 times/hour → 20 times/minute) (5) Functions: Changed (Input part) Number of input points: 2 → 4 Wiring: 3-wire → 2-wire A negative common type cannot be used. (Output part) Number of output points: 2 → 4 2 points/common → All points independent
	AJ55TB32-4DR (when negative common type is used)	A20SB-04US + A20PB-04RS	(1) External wiring: Changed (2) Number of modules: Changed (Two modules are required.) (3) Program: Changed (4) Specifications: (Input part) Rated input voltage: Not changed Rated input current: Not changed ON voltage/ON current: Changed OFF voltage/OFF current: Changed Input resistance: Not changed (Output part) Rated load voltage: Changed (The voltage that can be used is equivalent.) Rated load current: Not changed Maximum switching frequency: Changed (3600 times/hour → 20 times/minute) (5) Functions: Changed (Input part) Number of input points: 2 → 4 Wiring: 3-wire → 2-wire A positive common type cannot be used. (Output part) Number of output points: 2 → 4 2 points/common → All points independent
	AJ55TB32-8DR (when positive common type is used)	A20SB-04U + A20PB-04RS	(1) External wiring: Changed (2) Number of modules: Changed (Two modules are required.) (3) Program: Changed (4) Specifications: (Input part) Rated input voltage: Not changed Rated input current: Not changed ON voltage/ON current: Changed OFF voltage/OFF current: Changed Input resistance: Not changed (Output part) Rated load voltage: Changed (The voltage that can be used is equivalent.) Rated load current: Not changed Maximum switching frequency: Changed (3600 times/hour → 20 times/minute) (5) Functions: Changed (Input part) Wiring: 3-wire → 2-wire A negative common type cannot be used. (Output part) 4 points/common → All points independent

I/OLINK series model		AnyWire DB A20 series alternative model	
Product	Model name	Model name	Remarks (restrictions)
I/O module	AJ55TB32-8DR (when negative common type is used)	A20SB-04US + A20PB-04RS	(1) External wiring: Changed (2) Number of modules: Changed (Two modules are required.) (3) Program: Changed (4) Specifications: (Input part) Rated input voltage: Not changed Rated input current: Not changed ON voltage/ON current: Changed OFF voltage/OFF current: Changed Input resistance: Not changed (Output part) Rated load voltage: Changed (The voltage that can be used is equivalent.) Rated load current: Not changed Maximum switching frequency: Changed (3600 times/hour → 20 times/minute) (5) Functions: Changed (Input part) Wiring: 3-wire → 2-wire A positive common type cannot be used. (Output part) 4 points/common → All points independent
	AJ55TB32-16DR (when positive common type is used)	A20SB-08UD + A20PB-08RS	(1) External wiring: Changed (2) Number of modules: Changed (Two modules are required.) (3) Program: Changed (4) Specifications: (Input part) Rated input voltage: Not changed Rated input current: Not changed ON voltage/ON current: Changed OFF voltage/OFF current: Changed Input resistance: Not changed (Output part) Rated load voltage: Changed (The voltage that can be used is equivalent.) Rated load current: Not changed Maximum switching frequency: Changed (3600 times/hour → 20 times/minute) (5) Functions: Changed (Input part) A negative common type cannot be used. (Output part) 8 points/common → All points independent
	AJ55TB32-16DR (when negative common type is used)	A20SB-08USD-1 + A20PB-08RS	(1) External wiring: Changed (2) Number of modules: Changed (Two modules are required.) (3) Program: Changed (4) Specifications: (Input part) Rated input voltage: Not changed Rated input current: Not changed ON voltage/ON current: Changed OFF voltage/OFF current: Changed Input resistance: Not changed (Output part) Rated load voltage: Changed (The voltage that can be used is equivalent.) Rated load current: Not changed Maximum switching frequency: Changed (3600 times/hour → 20 times/minute) (5) Functions: Changed (Input part) A positive common type cannot be used. (Output part) 8 points/common → All points independent

I/OLINK series model		AnyWire DB A20 series alternative model	
Product	Model name	Model name	Remarks (restrictions)
I/O module	AJ55TB32-4DT	A20XB-16UD	(1) External wiring: Changed (2) Number of modules: Not changed (3) Program: Changed (4) Specifications: (Input part) Rated input voltage: Not changed Rated input current: Not changed ON voltage/ON current: Changed OFF voltage/OFF current: Changed Input resistance: Not changed (Output part) Rated load voltage: Not changed Rated load current: Changed (0.5A/point → 0.2A/point) (5) Functions: Changed (Input part) Number of input points: 2 → 8 (Output part) Number of output points: 2 → 8 Surge suppressor: Supported → Not supported
	AJ55TB32-8DT	A20XB-16UD	(1) External wiring: Changed (2) Number of modules: Not changed (3) Program: Changed (4) Specifications: (Input part) Rated input voltage: Not changed Rated input current: Not changed ON voltage/ON current: Changed OFF voltage/OFF current: Changed Input resistance: Not changed (Output part) Rated load voltage: Not changed Rated load current: Changed (0.5A/point → 0.2A/point) (5) Functions: Changed (Input part) Number of input points: 4 → 8 (Output part) Number of output points: 4 → 8 Surge suppressor: Supported → Not supported
	AJ55TB32-16DT	A20XB-16UD	(1) External wiring: Changed (2) Number of modules: Not changed (3) Program: Changed (4) Specifications: (Input part) Rated input voltage: Not changed Rated input current: Not changed ON voltage/ON current: Changed OFF voltage/OFF current: Changed Input resistance: Not changed (Output part) Rated load voltage: Not changed Rated load current: Changed (0.5A/point → 0.2A/point) (5) Functions: Changed (Input part) None (Output part) Surge suppressor: Supported → Not supported

6.2 I/O Module Specifications Comparisons

6.2.1 Input module specifications comparisons

(1) Comparisons between AJ55TB3-4D and A20SB-04U

○ : Compatible, △ : Partially changed, × : Not compatible

Specifications		AJ55TB3-4D	A20SB-04U	Compat- ibility	Precautions for replacement
Number of input points		4 points	4 points	○	
Insulation method		External input ↔ Internal circuit: Photocoupler Internal circuit ↔ Transmission circuit: Not insulated	External input ↔ Internal circuit: Not insulated Internal circuit ↔ Transmission circuit: Photocoupler	△	The insulated locations are different.
Input type		Positive/negative common shared type	Positive common type	△	A negative common type cannot be used.*1
Rated input voltage		24VDC	24VDC	○	
Rated input current		Approx. 7mA	Approx. 7mA	○	
Operating voltage range		19.2 to 26.4VDC (ripple ratio within 5%)	21.6 to 27.6VDC (ripple voltage 0.5Vp-p or less)	△	Operating voltage range is different.
Maximum simultaneous on input point		100%	100%	○	
ON voltage/ON current		14VDC or higher/3.5mA or higher	16VDC or higher/5.5mA or higher	△	ON voltage and ON current are increased.*2
OFF voltage/OFF current		6VDC or lower/1.7mA or lower	8VDC or lower/2mA or lower	△	OFF voltage and OFF current are increased.*2
Input resistance		Approx. 3.3kΩ	Approx. 3.3kΩ	○	
Response time	OFF → ON	10ms or less	1ms or less	○	
	ON → OFF	10ms or less	1ms or less	○	
Common terminal arrangement		4 points per common (3-wire type terminal block)	4 points per common (2-wire type terminal block)	△	To connect an item such as a 3-wire type sensor, an external common terminal block is required.
Operation indicator		ON indication (LED)	ON indication (LED)	○	
External wiring method		16-point terminal block (M3 screw) Transmission circuit included	10-point terminal block (M3 screw) Transmission circuit included	△	
Applicable wire size		0.75 to 2mm ²	0.3 to 1.25mm ² (when the following applicable crimping terminals are used: 0.75 to 2mm ²)	△	Wiring must be changed. Existing wires can be used but applicable crimping terminals are different.
Applicable crimping terminal		1.25-3, 1.25-YS3A, 2-S3, 2-YS3A V1.25-3, V1.25-YS3A, V2-S3, V2-YS3A	For wire sizes 0.75 to 2mm ² R2-3SL, RAV2-3SL, RAP2-3SL, VD2-3S, VD2-3.5SS, VD2-3.5S, VDAV2-3.5SS, VDAV2-3.5S	△	For details, refer to Section 6.3.
I/O module power supply	Voltage	15.6 to 27.6VDC	21.6 to 27.6VDC (ripple voltage 0.5Vp-p or less)	△	Operating voltage range is different.
	Current	35mA	50mA	△	Because the current consumption has increased, the current capacity must be reviewed.
External dimensions		50(H) × 82(W) × 66(D) mm	40(H) × 65(W) × 60(D) mm	△	The shape is different.
Installation method		Screw mounted	Screw mounted	×	Because mounting hole size is different, reworking is required.
		Mounted to DIN rail	Mounted to DIN rail	○	The A20SB-04U can be mounted to the existing DIN rail.
Weight		0.2kg	0.09kg	○	

*1 For the negative common type, use A20SB-04US.

*2 Check the specifications of the sensors or switches to be connected to the A20SB-04U.

(2) Comparisons between AJ55TB3-4D and A20SB-04US

○ : Compatible, △ : Partially changed, × : Not compatible

Specifications		AJ55TB3-4D	A20SB-04US	Compat- ibility	Precautions for replacement
Number of input points		4 points	4 points	○	
Insulation method		External input ↔ Internal circuit: Photocoupler Internal circuit ↔ Transmission circuit: Not insulated	External input ↔ Internal circuit: Not insulated Internal circuit ↔ Transmission circuit: Photocoupler	△	The insulated locations are different.
Input type		Positive/negative common shared type	Negative common type	△	A negative common type cannot be used.*1
Rated input voltage		24VDC	24VDC	○	
Rated input current		Approx. 7mA	Approx. 7mA	○	
Operating voltage range		19.2 to 26.4VDC (ripple ratio within 5%)	21.6 to 27.6VDC (ripple voltage 0.5Vp-p or less)	△	Operating voltage range is different.
Maximum simultaneous on input point		100%	100%	○	
ON voltage/ON current		14VDC or higher/3.5mA or higher	16VDC or higher/5.5mA or higher	△	ON voltage and ON current are increased.*2
OFF voltage/OFF current		6VDC or lower/1.7mA or lower	8VDC or lower/2mA or lower	△	OFF voltage and OFF current are increased.*2
Input resistance		Approx. 3.3kΩ	Approx. 3.3kΩ	○	
Response time	OFF → ON	10ms or less	1ms or less	○	
	ON → OFF	10ms or less	1ms or less	○	
Common terminal arrangement		4 points per common (3-wire type terminal block)	4 points per common (2-wire type terminal block)	△	To connect an item such as a 3-wire type sensor, an external common terminal block is required.
Operation indicator		ON indication (LED)	ON indication (LED)	○	
External wiring method		16-point terminal block (M3 screw) Transmission circuit included	10-point terminal block (M3 screw) Transmission circuit included	△	
Applicable wire size		0.75 to 2mm ²	0.3 to 1.25mm ² (when the following applicable crimping terminals are used: 0.75 to 2mm ²)	△	Wiring must be changed. Existing wires can be used but applicable crimping terminals are different.
Applicable crimping terminal		1.25-3, 1.25-YS3A, 2-S3, 2-YS3A, V1.25-3, V1.25-YS3A, V2-S3, V2-YS3A	For wire sizes 0.75 to 2mm ² R2-3SL, RAV2-3SL, RAP2-3SL, VD2-3S, VD2-3.5SS, VD2-3.5S, VDAV2-3.5SS, VDAV2-3.5S	△	For details, refer to Section 6.3.
I/O module power supply	Voltage	15.6 to 27.6VDC	21.6 to 27.6VDC (ripple voltage 0.5Vp-p or less)	△	Operating voltage range is different.
	Current	35mA	43mA	△	Because the current consumption has increased, the current capacity must be reviewed.
External dimensions		50(H) × 82(W) × 66(D) mm	40(H) × 65(W) × 60(D) mm	△	The shape is different.
Installation method		Screw mounted	Screw mounted	×	Because mounting hole size is different, reworking is required.
		Mounted to DIN rail	Mounted to DIN rail	○	The A20SB-04US can be mounted to the existing DIN rail.
Weight		0.2kg	0.09kg	○	

*1 For the positive common type, use A20SB-04U.

*2 Check the specifications of the sensors or switches to be connected to the A20SB-04US.

(3) Comparisons between AJ55TB3-8D and A20SB-08UD

○ : Compatible, △ : Partially changed, × : Not compatible

Specifications		AJ55TB3-8D	A20SB-08UD	Compat- ibility	Precautions for replacement
Number of input points		8 points	8 points	○	
Insulation method		External input ↔ Internal circuit: Photocoupler Internal circuit ↔ Transmission circuit: Not insulated	External input ↔ Internal circuit: Not insulated Internal circuit ↔ Transmission circuit: Photocoupler	△	The insulated locations are different.
Input type		Positive/negative common shared type	Positive common type	△	A negative common type cannot be used.*1
Rated input voltage		24VDC	24VDC	○	
Rated input current		Approx. 7mA	Approx. 7mA	○	
Operating voltage range		19.2 to 26.4VDC (ripple ratio within 5%)	21.6 to 27.6VDC (ripple voltage 0.5Vp-p or less)	△	Operating voltage range is different.
Maximum simultaneous on input point		100%	100%	○	
ON voltage/ON current		14VDC or higher/3.5mA or higher	16VDC or higher/5.5mA or higher	△	ON voltage and ON current are increased.*2
OFF voltage/OFF current		6VDC or lower/1.7mA or lower	8VDC or lower/2mA or lower	△	OFF voltage and OFF current are increased.*2
Input resistance		Approx. 3.3kΩ	Approx. 3.3kΩ	○	
Response time	OFF → ON	10ms or less	1ms or less	○	
	ON → OFF	10ms or less	1ms or less	○	
Common terminal arrangement		8 points per common (3-wire type terminal block)	8 points per common (3-wire type terminal block)	○	
Operation indicator		ON indication (LED)	ON indication (LED)	○	
External wiring method		24-point terminal block (M3 screw) Transmission circuit included	30-point terminal block (M3 screw) Transmission circuit included	△	
Applicable wire size		0.75 to 2mm ²	0.3 to 1.25mm ² (when the following applicable crimping terminals are used: 0.75 to 2mm ²)	△	Wiring must be changed. Existing wires can be used but applicable crimping terminals are different.
Applicable crimping terminal		1.25-3, 1.25-YS3A, 2-S3, 2-YS3A V1.25-3, V1.25-YS3A, V2-S3, V2-YS3A	For wire sizes 0.75 to 2mm ² R2-3SL, RAV2-3SL, RAP2-3SL, VD2-3S, VD2-3.5SS, VD2-3.5S, VDAV2-3.5SS, VDAV2-3.5S	△	For details, refer to Section 6.3.
I/O module power supply	Voltage	15.6 to 27.6VDC	21.6 to 27.6VDC (ripple voltage 0.5Vp-p or less)	△	Operating voltage range is different.
	Current	45mA	117mA	△	Because the current consumption has increased, the current capacity must be reviewed.
External dimensions		50(H) × 114(W) × 66(D) mm	40(H) × 140(W) × 60(D) mm	△	The shape is different.
Installation method		Screw mounted	Screw mounted	×	Because mounting hole size is different, reworking is required.
		Mounted to DIN rail	Mounted to DIN rail	○	The A20SB-08UD can be mounted to the existing DIN rail.
Weight		0.3kg	0.18kg	○	

*1 For the negative common type, use A20SB-08USD-1.

*2 Check the specifications of the sensors or switches to be connected to the A20SB-08UD.

(4) Comparisons between AJ55TB3-8D and A20SB-08USD-1

○ : Compatible, △ : Partially changed, × : Not compatible

Specifications		AJ55TB3-8D	A20SB-08USD-1	Compat- ibility	Precautions for replacement
Number of input points		8 points	8 points	○	
Insulation method		External input ↔ Internal circuit: Photocoupler Internal circuit ↔ Transmission circuit: Not insulated	External input ↔ Internal circuit: Not insulated Internal circuit ↔ Transmission circuit: Photocoupler	△	The insulated locations are different.
Input type		Positive/negative common shared type	Negative common type	△	A positive common type cannot be used.*1
Rated input voltage		24VDC	24VDC	○	
Rated input current		Approx. 7mA	Approx. 7mA	○	
Operating voltage range		19.2 to 26.4VDC (ripple ratio within 5%)	21.6 to 27.6VDC (ripple voltage 0.5Vp-p or less)	△	Operating voltage range is different.
Maximum simultaneous on input point		100%	100%	○	
ON voltage/ON current		14VDC or higher/3.5mA or higher	16VDC or higher/5.5mA or higher	△	ON voltage and ON current are increased.*2
OFF voltage/OFF current		6VDC or lower/1.7mA or lower	8VDC or lower/2mA or lower	△	OFF voltage and OFF current are increased.*2
Input resistance		Approx. 3.3kΩ	Approx. 3.3kΩ	○	
Response time	OFF → ON	10ms or less	1ms or less	○	
	ON → OFF	10ms or less	1ms or less	○	
Common terminal arrangement		8 points per common (3-wire type terminal block)	8 points per common (3-wire type terminal block)	○	
Operation indicator		ON indication (LED)	ON indication (LED)	○	
External wiring method		24-point terminal block (M3 screw) Transmission circuit included	30-point terminal block (M3 screw) Transmission circuit included	△	
Applicable wire size		0.75 to 2mm ²	0.3 to 1.25mm ² (when the following applicable crimping terminals are used: 0.75 to 2mm ²)	△	Wiring must be changed. Existing wires can be used but applicable crimping terminals are different.
Applicable crimping terminal		1.25-3, 1.25-YS3A, 2-S3, 2-YS3A V1.25-3, V1.25-YS3A, V2-S3, V2-YS3A	For wire sizes 0.75 to 2mm ² R2-3SL, RAV2-3SL, RAP2-3SL, VD2-3S, VD2-3.5SS, VD2-3.5S, VDAV2-3.5SS, VDAV2-3.5S	△	For details, refer to Section 6.3.
I/O module power supply	Voltage	15.6 to 27.6VDC	21.6 to 27.6VDC (ripple voltage 0.5Vp-p or less)	△	Operating voltage range is different.
	Current	45mA	117mA	△	Because the current consumption has increased, the current capacity must be reviewed.
External dimensions		50(H) × 114(W) × 66(D) mm	40(H) × 140(W) × 60(D) mm	△	The shape is different.
Installation method		Screw mounted	Screw mounted	×	Because mounting hole size is different, reworking is required.
		Mounted to DIN rail	Mounted to DIN rail	○	The A20SB-08USD-1 can be mounted to the existing DIN rail.
Weight		0.3kg	0.25kg	○	

*1 For the positive common type, use A20SB-08UD.

*2 Check the specifications of the sensors or switches to be connected to the A20SB-08USD-1.

(5) Comparisons between AJ55TB3-16D and A20SB-16UD

○ : Compatible, △ : Partially changed, × : Not compatible

Specifications		AJ55TB3-16D	A20SB-16UD	Compat- ibility	Precautions for replacement
Number of input points		16 points	16 points	○	
Insulation method		External input ↔ Internal circuit: Photocoupler Internal circuit ↔ Transmission circuit: Not insulated	External input ↔ Internal circuit: Not insulated Internal circuit ↔ Transmission circuit: Photocoupler	△	The insulated locations are different.
Input type		Positive/negative common shared type	Positive common type	△	A negative common type cannot be used.*1
Rated input voltage		24VDC	24VDC	○	
Rated input current		Approx. 7mA	Approx. 7mA	○	
Operating voltage range		19.2 to 26.4VDC (ripple ratio within 5%)	21.6 to 27.6VDC (ripple voltage 0.5Vp-p or less)	△	Operating voltage range is different.
Maximum simultaneous on input point		100%	100%	○	
ON voltage/ON current		14VDC or higher/3.5mA or higher	16VDC or higher/5.5mA or higher	△	ON voltage and ON current are increased.*2
OFF voltage/OFF current		6VDC or lower/1.7mA or lower	8VDC or lower/2mA or lower	△	OFF voltage and OFF current are increased.*2
Input resistance		Approx. 3.3kΩ	Approx. 3.3kΩ	○	
Response time	OFF → ON	10ms or less	1ms or less	○	
	ON → OFF	10ms or less	1ms or less	○	
Common terminal arrangement		8 points per common (3-wire type terminal block)	16 points per common (3-wire type terminal block)	△	The A20SB-16UD changes from 2 commons to 1 common.
Operation indicator		ON indication (LED)	ON indication (LED)	○	
External wiring method		40-point terminal block (M3 screw) Transmission circuit included	40-point terminal block (M3 screw) Transmission circuit included	△	Wiring must be changed. Existing wires can be used but applicable crimping terminals are different. For details, refer to Section 6.3.
Applicable wire size		0.75 to 2mm ²	0.3 to 1.25mm ² (when the following applicable crimping terminals are used: 0.75 to 2mm ²)	△	
Applicable crimping terminal		1.25-3, 1.25-YS3A, 2-S3, 2-YS3A V1.25-3, V1.25-YS3A, V2-S3, V2-YS3A	For wire sizes 0.75 to 2mm ² R2-3SL, RAV2-3SL, RAP2-3SL, VD2-3S, VD2-3.5SS, VD2-3.5S, VDAV2-3.5SS, VDAV2-3.5S	△	
I/O module power supply	Voltage	15.6 to 27.6VDC	21.6 to 27.6VDC (ripple voltage 0.5Vp-p or less)	△	Operating voltage range is different.
	Current	60mA	233mA	△	Because the current consumption has increased, the current capacity must be reviewed.
External dimensions		50(H) × 177(W) × 66(D) mm	40(H) × 190(W) × 60(D) mm	△	The shape is different.
Installation method		Screw mounted	Screw mounted	×	Because mounting hole size is different, reworking is required.
		Mounted to DIN rail	Mounted to DIN rail	○	The A20SB-16UD can be mounted to the existing DIN rail.
Weight		0.4kg	0.24kg	○	

*1 For the negative common type, use A20SB-16USD.

*2 Check the specifications of the sensors or switches to be connected to the A20SB-16UD.

(6) Comparisons between AJ55TB3-16D and A20SB-16USD

○ : Compatible, △ : Partially changed, × : Not compatible

Specifications		AJ55TB3-16D	A20SB-16USD	Compat- ibility	Precautions for replacement
Number of input points		16 points	16 points	○	
Insulation method		External input ↔ Internal circuit: Photocoupler Internal circuit ↔ Transmission circuit: Not insulated	External input ↔ Internal circuit: Not insulated Internal circuit ↔ Transmission circuit: Photocoupler	△	The insulated locations are different.
Input type		Positive/negative common shared type	Negative common type	△	A positive common type cannot be used.*1
Rated input voltage		24VDC	24VDC	○	
Rated input current		Approx. 7mA	Approx. 7mA	○	
Operating voltage range		19.2 to 26.4VDC (ripple ratio within 5%)	21.6 to 27.6VDC (ripple voltage 0.5Vp-p or less)	△	Operating voltage range is different.
Maximum simultaneous on input point		100%	100%	○	
ON voltage/ON current		14VDC or higher/3.5mA or higher	16VDC or higher/4.5mA or higher	△	ON voltage and ON current are increased.*2
OFF voltage/OFF current		6VDC or lower/1.7mA or lower	6VDC or lower/1mA or lower	△	OFF current is decreased.*2
Input resistance		Approx. 3.3kΩ	Approx. 3.3kΩ	○	
Response time	OFF → ON	10ms or less	1ms or less	○	
	ON → OFF	10ms or less	1ms or less	○	
Common terminal arrangement		8 points per common (3-wire type terminal block)	16 points per common (3-wire type terminal block)	△	The A20SB-16USD changes from 2 commons to 1 common.
Operation indicator		ON indication (LED)	ON indication (LED)	○	
External wiring method		40-point terminal block (M3 screw) Transmission circuit included	40-point terminal block (M3 screw) Transmission circuit included	△	
Applicable wire size		0.75 to 2mm ²	0.3 to 1.25mm ² (when the following applicable crimping terminals are used: 0.75 to 2mm ²)	△	Wiring must be changed. Existing wires can be used but applicable crimping terminals are different.
Applicable crimping terminal		1.25-3, 1.25-YS3A, 2-S3, 2-YS3A V1.25-3, V1.25-YS3A, V2-S3, V2-YS3A	For wire sizes 0.75 to 2mm ² R2-3SL, RAV2-3SL, RAP2-3SL, VD2-3S, VD2-3.5SS, VD2-3.5S, VDAV2-3.5SS, VDAV2-3.5S	△	For details, refer to Section 6.3.
I/O module power supply	Voltage	15.6 to 27.6VDC	21.6 to 27.6VDC (ripple voltage 0.5Vp-p or less)	△	Operating voltage range is different.
	Current	60mA	233mA	△	Because the current consumption has increased, the current capacity must be reviewed.
External dimensions		50(H) × 177(W) × 66(D) mm	40(H) × 190(W) × 60(D) mm	△	The shape is different.
Installation method		Screw mounted	Screw mounted	×	Because mounting hole size is different, reworking is required.
		Mounted to DIN rail	Mounted to DIN rail	○	The A20SB-16USD can be mounted to the existing DIN rail.
Weight		0.4kg	0.24kg	○	

*1 For the positive common type, use A20SB-16UD.

*2 Check the specifications of the sensors or switches to be connected to the A20SB-16USD.

6.2.2 Output module specifications

(1) Comparisons between AJ55TB2-4R and A20PB-04RS

○ : Compatible, △ : Partially changed, × : Not compatible

Specifications		AJ55TB2-4R	A20PB-04RS	Compat- ibility	Precautions for replacement
Number of output points		4 points	4 points	○	
Insulation method		External output ↔ Internal circuit: Photocoupler Internal circuit ↔ Transmission circuit: Not insulated	External output ↔ Internal circuit: Relay Internal circuit ↔ Transmission circuit: Photocoupler	△	The insulation method is different.
Output type		Contact output type	Contact output type	○	
Rated load voltage/current		24VDC 2A (resistance load)/point 240VAC 2A (COSφ=1)/point 8A/common	30VDC 2A (resistance load)/point 220VAC 2A (COSφ=1)/point 1A (induced load)/point	△	The rated load voltage and current are different.
Minimum switching load		5VDC 1mA	0.1VDC 0.1mA (reference value)	△	Check the specifications of the load to be used.
Maximum switching voltage		250VAC 110VDC	250VAC 110VDC	○	
Response time	OFF → ON	10ms or less	10ms or less	○	
	ON → OFF	12ms or less	10ms or less	○	
Life	Mechanical	20 million times or more	20 million times or more	○	
	Electrical	Rated switching voltage/current load 100,000 times or more 200VAC 1.5A, 240VAC 1A (COSφ=0.7) 100,000 times or more 200VAC 1A, 240VAC 0.5A (COSφ=0.35) 100,000 times or more 24VDC 1A, 100VDC 0.1A (L/R=7ms) 100,000 times or more	100,000 times or more	○	
Maximum switching frequency		3,600 times/hour	20 times/minute	△	Maximum switching frequency is different.
Surge suppressor		None	None	–	
Common terminal arrangement		4 points per common (2-wire type terminal block)	All points independent (2-wire type terminal block)	△	Because 4 points per common is changed to all points independent, the wiring is different.
Operation indicator		ON indication (LED)	ON indication (LED)	○	
External wiring method		16-point terminal block (M3 screw) Transmission circuit included	20-point terminal block Transmission circuit included	△	
Applicable wire size		0.75 to 2mm ²	0.3 to 1.25mm ² (when the following applicable crimping terminals are used: 0.75 to 2mm ²)	△	Wiring must be changed. Existing wires can be used but applicable crimping terminals are different.
Applicable crimping terminal		1.25-3, 1.25-YS3A, 2-S3, 2-YS3A V1.25-3, V1.25-YS3A, V2-S3, V2-YS3A	For wire sizes 0.75 to 2mm ² R2-3SL, RAV2-3SL, RAP2-3SL, VD2-3S, VD2-3.5SS, VD2-3.5S, VDAV2-3.5SS, VDAV2-3.5S	△	For details, refer to Section 6.3.
External power supply	Voltage	24VDC ± 10% Ripple voltage 4Vp-p or less	–	–	The A20PB-04RS external power supply and the I/O module power supply are shared.
	Current	23mA (24VDC TYP. all points ON)	–	–	
I/O module power supply	Voltage	15.6 to 27.6VDC	21.6 to 27.6VDC (ripple voltage 0.5Vp-p or less)	△	Operating voltage range is different.
	Current	50mA	90mA	△	Because the current consumption has increased, the current capacity must be reviewed.
External dimensions		50(H) × 82(W) × 66(D) mm	40(H) × 100(W) × 60(D) mm	△	The shape is different.
Installation method		Screw mounted	Screw mounted	×	Because mounting hole size is different, reworking is required.
		Mounted to DIN rail	Mounted to DIN rail	○	The A20PB-04RS can be mounted to the existing DIN rail.
Weight		0.2kg	0.14kg	○	

(2) Comparisons between AJ55TB2-8R and A20PB-08RS

○ : Compatible, △ : Partially changed, × : Not compatible

Specifications		AJ55TB2-8R	A20PB-08RS	Compat- ibility	Precautions for replacement
Number of output points		8 points	8 points	○	
Insulation method		External output ↔ Internal circuit: Photocoupler Internal circuit ↔ Transmission circuit: Not insulated	External output ↔ Internal circuit: Relay Internal circuit ↔ Transmission circuit: Photocoupler	△	The insulation method is different.
Output type		Contact output type	Contact output type	○	
Rated load voltage/current		24VDC 2A (resistance load)/point 240VAC 2A (COSφ=1)/point 8A/common	30VDC 2A (resistance load)/point 220VAC 2A (COSφ=1)/point 1A (induced load)/point	△	The rated load voltage and current are different.
Minimum switching load		5VDC 1mA	0.1VDC 0.1mA (reference value)	△	Check the specifications of the load to be used.
Maximum switching voltage		250VAC 110VDC	250VAC 110VDC	○	
Response time	OFF → ON	10ms or less	10ms or less	○	
	ON → OFF	12ms or less	10ms or less	○	
Life	Mechanical	20 million times or more	20 million times or more	○	
	Electrical	Rated switching voltage/current load 100,000 times or more 200VAC 1.5A, 240VAC 1A (COSφ=0.7) 100,000 times or more 200VAC 1A, 240VAC 0.5A (COSφ=0.35) 100,000 times or more 24VDC 1A, 100VDC 0.1A (L/R=7ms) 100,000 times or more	100,000 times or more	○	
Maximum switching frequency		3,600 times/hour	20 times/minute	△	Maximum switching frequency is different.
Surge suppressor		None	None	–	
Common terminal arrangement		8 points per common (2-wire type terminal block)	All points independent (2-wire type terminal block)	△	Because 8 points per common is changed to all points independent, the wiring is different.
Operation indicator		ON indication (LED)	ON indication (LED)	○	
External wiring method		24-point terminal block (M3 screw) Transmission circuit included	30-point terminal block (M3 screw) Transmission circuit included	△	
Applicable wire size		0.75 to 2mm ²	0.3 to 1.25mm ² (when the following applicable crimping terminals are used: 0.75 to 2mm ²)	△	Wiring must be changed. Existing wires can be used but applicable crimping terminals are different.
Applicable crimping terminal		1.25-3, 1.25-YS3A, 2-S3, 2-YS3A V1.25-3, V1.25-YS3A, V2-S3, V2-YS3A	For wire sizes 0.75 to 2mm ² R2-3SL, RAV2-3SL, RAP2-3SL, VD2-3S, VD2-3.5SS, VD2-3.5S, VDAV2-3.5SS, VDAV2-3.5S	△	For details, refer to Section 6.3.
External power supply	Voltage	24VDC ± 10% Ripple voltage 4Vp-p or less	–	–	The A20PB-08RS external power supply and the I/O module power supply are shared.
	Current	45mA (24VDC TYP. all points ON)	–	–	
I/O module power supply	Voltage	15.6 to 27.6VDC	21.6 to 27.6VDC (ripple voltage 0.5Vp-p or less)	△	Operating voltage range is different.
	Current	65mA	104mA	○	Because the external power supply and the I/O module power supply are shared, the consumed current is decreased.
External dimensions		50(H) × 114(W) × 66(D) mm	40(H) × 140(W) × 60(D) mm	△	The shape is different.
Installation method		Screw mounted	Screw mounted	×	Because mounting hole size is different, reworking is required.
		Mounted to DIN rail	Mounted to DIN rail	○	The A20PB-08RS can be mounted to the existing DIN rail.
Weight		0.3kg	0.2kg	○	

(3) Comparisons between AJ55TB2-16R and A20PB-16RS

○ : Compatible, △ : Partially changed, × : Not compatible

Specifications		AJ55TB2-16R	A20PB-16RS	Compat- ibility	Precautions for replacement
Number of output points		16 points	16 points	○	
Insulation method		External output ↔ Internal circuit: Photocoupler Internal circuit ↔ Transmission circuit: Not insulated	External output ↔ Internal circuit: Relay Internal circuit ↔ Transmission circuit: Photocoupler	△	The insulation method is different.
Output type		Contact output type	Contact output type	○	
Rated load voltage/current		24VDC 2A (resistance load)/point 240VAC 2A (COSφ=1)/point 8A/common	30VDC 2A (resistance load)/point 220VAC 2A (COSφ=1)/point 1A (induced load)/point	△	The rated load voltage and current are different.
Minimum switching load		5VDC 1mA	0.1VDC 0.1mA (reference value)	△	Check the specifications of the load to be used.
Maximum switching voltage		250VAC 110VDC	250VAC 110VDC	○	
Response time	OFF → ON	10ms or less	10ms or less	○	
	ON → OFF	12ms or less	10ms or less	○	
Life	Mechanical	20 million times or more	20 million times or more	○	
	Electrical	Rated switching voltage/current load 100,000 times or more 200VAC 1.5A, 240VAC 1A (COSφ=0.7) 100,000 times or more 200VAC 1A, 240VAC 0.5A (COSφ=0.35) 100,000 times or more 24VDC 1A, 100VDC 0.1A (L/R=7ms) 100,000 times or more	100,000 times or more	○	
Maximum switching frequency		3,600 times/hour	20 times/minute	△	Maximum switching frequency is different.
Surge suppressor		None	None	–	
Common terminal arrangement		8 points per common (2-wire type terminal block)	All points independent (2-wire type terminal block)	△	Because 8 points per common is changed to all points independent, the wiring is different.
Operation indicator		ON indication (LED)	ON indication (LED)	○	
External wiring method		40-point terminal block (M3 screw) Transmission circuit included	40-point terminal block (M3 screw) Transmission circuit included	△	Existing wires can be used but applicable crimping terminals are different. For details, refer to Section 6.3.
Applicable wire size		0.75 to 2mm ²	0.3 to 1.25mm ² (when the following applicable crimping terminals are used: 0.75 to 2mm ²)	△	
Applicable crimping terminal		1.25-3, 1.25-YS3A, 2-S3, 2-YS3A V1.25-3, V1.25-YS3A, V2-S3, V2-YS3A	For wire sizes 0.75 to 2mm ² R2-3SL, RAV2-3SL, RAP2-3SL, VD2-3S, VD2-3.5SS, VD2-3.5S, VDAV2-3.5SS, VDAV2-3.5S	△	
External power supply	Voltage	24VDC ± 10% Ripple voltage 4Vp-p or less	–	–	The A20PB-16RS external power supply and the I/O module power supply are shared.
	Current	90mA (24VDC TYP. all points ON)	–	–	
I/O module power supply	Voltage	15.6 to 27.6VDC	21.6 to 27.6VDC (ripple voltage 0.5Vp-p or less)	△	Operating voltage range is different.
	Current	85mA	165mA	○	Because the external power supply and the I/O module power supply are shared, the consumed current is decreased.
External dimensions		50(H) × 177(W) × 66(D) mm	40(H) × 190(W) × 60(D) mm	△	The shape is different.
Installation method		Screw mounted	Screw mounted	×	Because mounting hole size is different, reworking is required.
		Mounted to DIN rail	Mounted to DIN rail	○	The A20PB-16RS can be mounted to the existing DIN rail.
Weight		0.4kg	0.28kg	○	

(4) Comparisons between AJ55TB2-4T and A20PB-04U

○ : Compatible, △ : Partially changed, × : Not compatible

Specifications		AJ55TB2-4T	A20PB-04U	Compat- ibility	Precautions for replacement
Number of output points		4 points	4 points	○	
Insulation method		External output ↔ Internal circuit: Photocoupler Internal circuit ↔ Transmission circuit: Not insulated	External output ↔ Internal circuit: Not insulated Internal circuit ↔ Transmission circuit: Photocoupler	△	The insulated locations are different.
Output type		Sink type	Sink type	○	
Rated load voltage		12/24VDC	24VDC	△	12VDC cannot be used.*1
Operating load voltage range		10.2 to 30VDC (peak voltage 30VDC)	21.6 to 27.6VDC (ripple voltage 0.5Vp-p or less)	△	Operating voltage range is different.
Maximum load voltage		0.5A/point 2A/common	0.2A/point 0.8A/common	△	The maximum load current per point has decreased. Check the specifications of the load to be used.
Maximum inrush current		4A, 10ms or less	500mA or lower	△	Inrush current has decreased. Check the specifications of the load to be used.
Leakage current at OFF		0.1mA or lower	0.1mA or lower	○	
Maximum voltage drop at ON		0.9VDC or lower (TYP.) 0.5A 1.5VDC or lower (MAX.) 0.5A	1V or lower	△	Check the specifications of the load to be used.
Response time	OFF → ON	2ms or less	1ms or less	○	
	ON → OFF	2ms or less (resistance load)	1ms or less	○	
Surge suppressor		Zener diode	None	×	The surge suppressor is not built-in.
Common terminal arrangement		4 points per common (2-wire type terminal block)	4 points per common (2-wire type terminal block)	○	
Operation indicator		ON indication (LED)	ON indication (LED)	○	
External wiring method		16-point terminal block (M3 screw) Transmission circuit included	10-point terminal block (M3 screw) Transmission circuit included	△	Wiring must be changed.
Applicable wire size		0.75 to 2mm ²	0.3 to 1.25mm ² (when the following applicable crimping terminals are used: 0.75 to 2mm ²)	△	Existing wires can be used but applicable crimping terminals are different.
Applicable crimping terminal		1.25-3, 1.25-YS3A, 2-S3, 2-YS3A, V1.25-3, V1.25-YS3A, V2-S3, V2-YS3A	For wire sizes 0.75 to 2mm ² R2-3SL, RAV2-3SL, RAP2-3SL, VD2-3S, VD2-3.5SS, VD2-3.5S, VDAV2-3.5SS, VDAV2-3.5S	△	For details, refer to Section 6.3.
External power supply	Voltage	10.2 to 30VDC	–	–	The A20PB-04U external power supply and the I/O module power supply are shared.
	Current	30mA (24VDC TYP. per 1 common)	–	–	
I/O module power supply	Voltage	15.6 to 27.6VDC	21.6 to 27.6VDC (ripple voltage 0.5Vp-p or less)	△	Operating voltage range is different.
	Current	45mA	13mA	○	Because the external power supply and the I/O module power supply are shared, the consumed current is decreased.
External dimensions		50(H) × 82(W) × 66(D) mm	40(H) × 65(W) × 60(D) mm	△	The shape is different.
Installation method		Screw mounted	Screw mounted	×	Because mounting hole size is different, reworking is required.
		Mounted to DIN rail	Mounted to DIN rail	○	The A20PB-04U can be mounted to the existing DIN rail.
Weight		0.2kg	0.09g	○	

*1 When used on 12VDC, consider the use of an external relay.

(5) Comparisons between AJ55TB2-8T and A20PB-08U

○ : Compatible, △ : Partially changed, × : Not compatible

Specifications		AJ55TB2-8T	A20PB-08U	Compat- ibility	Precautions for replacement
Number of output points		8 points	8 points	○	
Insulation method		External output ↔ Internal circuit: Photocoupler Internal circuit ↔ Transmission circuit: Not insulated	External output ↔ Internal circuit: Not insulated Internal circuit ↔ Transmission circuit: Photocoupler	△	The insulated locations are different.
Output type		Sink type	Sink type	○	
Rated load voltage		12/24VDC	24VDC	△	12VDC cannot be used.*1
Operating load voltage range		10.2 to 30VDC (peak voltage 30VDC)	21.6 to 27.6VDC (ripple voltage 0.5Vp-p or less)	△	Operating voltage range is different.
Maximum load voltage		0.5A/point 4A/common	0.2A/point 1.6A/common	△	The maximum load current per point has decreased. Check the specifications of the load to be used.
Maximum inrush current		4A, 10ms or less	500mA or lower	△	Inrush current has decreased. Check the specifications of the load to be used.
Leakage current at OFF		0.1mA or lower	0.1mA or lower	○	
Maximum voltage drop at ON		0.9VDC or lower (TYP.) 0.5A 1.5VDC or lower (MAX.) 0.5A	1V or lower	△	Check the specifications of the load to be used.
Response time	OFF → ON	2ms or less	1ms or less	○	
	ON → OFF	2ms or less (resistance load)	1ms or less	○	
Surge suppressor		Zener diode	None	×	The surge suppressor is not built-in.
Common terminal arrangement		8 points per common (2-wire type terminal block)	8 points per common (2-wire type terminal block)	○	
Operation indicator		ON indication (LED)	ON indication (LED)	○	
External wiring method		24-point terminal block (M3 screw) Transmission circuit included	20-point terminal block (M3 screw) Transmission circuit included	△	
Applicable wire size		0.75 to 2mm ²	0.3 to 1.25mm ² (when the following applicable crimping terminals are used: 0.75 to 2mm ²)	△	Wiring must be changed. Existing wires can be used but applicable crimping terminals are different.
Applicable crimping terminal		1.25-3, 1.25-YS3A, 2-S3, 2-YS3A V1.25-3, V1.25-YS3A, V2-S3, V2-YS3A	For wire sizes 0.75 to 2mm ² R2-3SL, RAV2-3SL, RAP2-3SL, VD2-3S, VD2-3.5SS, VD2-3.5S, VDAV2-3.5SS, VDAV2-3.5S	△	For details, refer to Section 6.3.
External power supply	Voltage	10.2 to 30VDC	—	—	External power supply for the A20PB-08U is unnecessary.
	Current	30mA (24VDC TYP. per 1 common)	—	—	
I/O module power supply	Voltage	15.6 to 27.6VDC (peak voltage 27.6VDC)	21.6 to 27.6VDC (ripple voltage 0.5Vp-p or less)	△	Operating voltage range is different.
	Current	55mA	21mA	○	Because the external power supply and the I/O module power supply are shared, the consumed current is decreased.
External dimensions		50(H) × 114(W) × 66(D) mm	40(H) × 100(W) × 60(D) mm	△	The shape is different.
Installation method		Screw mounted	Screw mounted	×	Because mounting hole size is different, reworking is required.
		Mounted to DIN rail	Mounted to DIN rail	○	The A20PB-08U can be mounted to the existing DIN rail.
Weight		0.3kg	0.13g	○	

*1 When used on 12VDC, consider the use of an external relay.

(6) Comparisons between AJ55TB2-16T and A20PB-16U

○ : Compatible, △ : Partially changed, × : Not compatible

Specifications		AJ55TB2-16T	A20PB-16U	Compat- ibility	Precautions for replacement
Number of output points		16 points	16 points	○	
Insulation method		External output ↔ Internal circuit: Photocoupler Internal circuit ↔ Transmission circuit: Not insulated	External output ↔ Internal circuit: Not insulated Internal circuit ↔ Transmission circuit: Photocoupler	△	The insulated locations are different.
Output type		Sink type	Sink type	○	
Rated load voltage		12/24VDC	24VDC	△	12VDC cannot be used.*1
Operating load voltage range		10.2 to 30VDC (peak voltage 30VDC)	21.6 to 27.6VDC (ripple voltage 0.5Vp-p or less)	△	Operating voltage range is different.
Maximum load voltage		0.5A/point 5A/common	0.2A/point 3.2A/common	△	The maximum load current per point has decreased. Check the specifications of the load to be used.
Maximum inrush current		4.0A, 10ms or less	500mA or lower	△	Inrush current has decreased. Check the specifications of the load to be used.
Leakage current at OFF		0.1mA or lower	0.1mA or lower	○	
Maximum voltage drop at ON		0.9VDC or lower (TYP.) 0.5A 1.5VDC or lower (MAX.) 0.5A	1V or lower	△	Check the specifications of the load to be used.
Response time	OFF → ON	2ms or less	1ms or less	○	
	ON → OFF	2ms or less (resistance load)	1ms or less	○	
Surge suppressor		Zener diode	None	×	The surge suppressor is not built-in.
Common terminal arrangement		16 points per common (2-wire type terminal block)	16 points per common (2-wire type terminal block)	○	
Operation indicator		ON indication (LED)	ON indication (LED)	○	
External wiring method		40-point terminal block (M3 screw) Transmission circuit included	30-point terminal block (M3 screw) Transmission circuit included	△	
Applicable wire size		0.75 to 2mm ²	0.3 to 1.25mm ² (when the following applicable crimping terminals are used: 0.75 to 2mm ²)	△	Wiring must be changed. Existing wires can be used but applicable crimping terminals are different.
Applicable crimping terminal		1.25-3, 1.25-YS3A, 2-S3, 2-YS3A, V1.25-3, V1.25-YS3A, V2-S3, V2-YS3A	For wire sizes 0.75 to 2mm ² R2-3SL, RAV2-3SL, RAP2-3SL, VD2-3S, VD2-3.5SS, VD2-3.5S, VDAV2-3.5SS, VDAV2-3.5S	△	For details, refer to Section 6.3.
External power supply	Voltage	10.2 to 30VDC	–	–	The A20PB-16U external power supply and the I/O module power supply are shared.
	Current	120mA (24VDC TYP. per 1 common)	–	–	
I/O module power supply	Voltage	15.6 to 27.6VDC (peak voltage 27.6VDC)	21.6 to 27.6VDC (ripple voltage 0.5Vp-p or less)	△	Operating voltage range is different.
	Current	70mA	33mA	○	Because the external power supply and the I/O module power supply are shared, the consumed current is decreased.
External dimensions		50(H) × 177(W) × 66(D) mm	40(H) × 140(W) × 60(D) mm	△	The shape is different.
Installation method		Screw mounted	Screw mounted	×	Because mounting hole size is different, reworking is required.
		Mounted to DIN rail	Mounted to DIN rail	○	The A20PB-16U can be mounted to the existing DIN rail.
Weight		0.4kg	0.18g	○	

*1 When used on 12VDC, consider the use of an external relay.

6.2.3 I/O module specifications comparisons

(1) Comparisons between AJ55TB32-4DR and A20SB-04U + A20PB-04RS

○ : Compatible, △ : Partially changed, × : Not compatible

Specifications	AJ55TB32-4DR input specifications	A20SB-04U input specifications	Compat- ibility	Precautions for replacement
Number of input points	2 points	4 points	○	
Insulation method	External input ↔ Internal circuit: Photocoupler Internal circuit ↔ Transmission circuit: Not insulated	External input ↔ Internal circuit: Not insulated Internal circuit ↔ Transmission circuit: Photocoupler	△	The insulated locations are different.
Input type	Positive/negative common shared type	Positive common type	△	A negative common type cannot be used.*1
Rated input voltage	24VDC	24VDC	○	
Rated input current	Approx. 7mA	Approx. 7mA	○	
Operating voltage range	21.6 to 26.4VDC (ripple voltage 4Vp-p or less)	21.6 to 27.6VDC (ripple voltage 0.5Vp-p or less)	△	Operating voltage range is different.
Maximum simultaneous on input point	100%	100%	○	
ON voltage/ON current	14VDC or higher/3.5mA or higher	16VDC or higher/5.5mA or higher	△	ON voltage and ON current are increased.*2
OFF voltage/OFF current	6VDC or lower/1.7mA or lower	8VDC or lower/2mA or lower	△	OFF voltage and OFF current are increased.*2
Input resistance	Approx. 3.3kΩ	Approx. 3.3kΩ	○	
Response time	OFF → ON	10ms or less	○	
	ON → OFF	10ms or less	○	
Common terminal arrangement	2 points per common (3-wire type terminal block)	4 points per common (2-wire type terminal block)	△	To connect an item such as a 3-wire type sensor, an external common terminal block is required.

Specifications		AJ55TB32-4DR output specifications	A20PB-04RS output specifications	Compat- ibility	Precautions for replacement
Number of output points		2 points	4 points	○	
Insulation method		External output ↔ Internal circuit: Photocoupler Internal circuit ↔ Transmission circuit: Not insulated	External output ↔ Internal circuit: Relay Internal circuit ↔ Transmission circuit: Photocoupler	△	The insulation method is different.
Output type		Contact output type	Contact output type	○	
Rated load voltage/current		24VDC 2A (resistance load)/point 240VAC 2A (COSφ=1)/point 4A/common	30VDC 2A (resistance load)/point 220VAC 2A (COSφ=1)/point 1A (induced load)/point	△	The rated load voltage and current are different.
Minimum switching load		5VDC 1mA	0.1VDC 0.1mA (reference value)	△	Check the specifications of the load to be used.
Maximum switching voltage		250VAC 110VDC	250VAC 110VDC	○	
Response time	OFF → ON	10ms or less	10ms or less	○	
	ON → OFF	12ms or less	10ms or less	○	
Life	Mechanical	20 million times or more	20 million times or more	○	
	Electrical	Rated switching voltage/current load 100,000 times or more 200VAC 1.5A, 240VAC 1A (COSφ=0.7) 100,000 times or more 200VAC 1A, 240VAC 0.5A (COSφ=0.35) 100,000 times or more 24VDC 1A, 100VDC 0.1A (L/R=7ms) 100,000 times or more	100,000 times or more	○	
Maximum switching frequency		3,600 times/hour	20 times/minute	△	Maximum switching frequency is different.
Surge suppressor		None	None	-	
Common terminal arrangement		2 points per common (2-wire type terminal block)	All points independent (2-wire type terminal block)	△	Because 2 points per common is changed to all points independent, the wiring is different.

*1 For the negative common type, use the A20SB-04US.

*2 Check the specifications of the sensors or switches to be connected to the A20SB-04U.

○ : Compatible, △ : Partially changed, × : Not compatible

Specifications		AJ55TB32-4DR	A20SB-04U	A20PB-04RS	Compat- ibility	Precautions for replacement
Operation indicator		ON indication (LED)	ON indication (LED)		○	
External wiring method		16-point terminal block (M3 screw) Transmission circuit included	10-point terminal block (M3 screw) Transmission circuit included	20-point terminal block (M3 screw) Transmission circuit included	△	Wiring must be changed. Existing wires can be used but applicable crimping terminals are different. For details, refer to Section 6.3.
Applicable wire size		0.75 to 2mm ²	0.3 to 1.25mm ² (when the following applicable crimping terminals are used: 0.75 to 2mm ²)		△	
Applicable crimping terminal		1.25-3, 1.25-YS3A, 2-S3, 2-YS3A V1.25-3, V1.25-YS3A, V2-S3, V2-YS3A	For wire sizes 0.75 to 2mm ² R2-3SL, RAV2-3SL, RAP2-3SL, VD2-3S, VD2-3.5SS, VD2-3.5S, VDAV2-3.5SS, VDAV2-3.5S		△	
External power supply	Voltage	24VDC ± 10% Ripple voltage 4Vp-p or less	–	–	–	External power supply for the A20SB-04U is unnecessary. The A20PB-04RS external power supply and the I/O module power supply are shared.
	Current	12mA (24VDC TYP. all points ON)	–	–	–	
I/O module power supply	Voltage	15.6 to 27.6VDC	21.6 to 27.6VDC (ripple voltage 0.5Vp-p or less)		△	Operating voltage range is different.
	Current	40mA	50mA	90mA	△	Because the current consumption has increased, the current capacity must be reviewed.
External dimensions		50(H) × 82(W) × 66(D) mm	40(H) × 65(W) × 60(D) mm	40(H) × 100(W) × 60(D) mm	×	The shape is different. A mounting space for two modules is required.
Installation method		Screw mounted	Screw mounted		×	Because mounting hole size is different, reworking is required.
		Mounted to DIN rail	Mounted to DIN rail		△	The A20SB-04U and A20PB- 04RS can be mounted to the existing DIN rail. Be careful about the mounting dimensions as two modules are required.
Weight		0.2kg	0.09kg	0.14kg	△	The weight is increased.

(2) Comparisons between AJ55TB32-4DR and A20SB-04US + A20PB-04RS

○ : Compatible, △ : Partially changed, × : Not compatible

Specifications	AJ55TB32-4DR input specifications	A20SB-04US input specifications	Compat-ibility	Precautions for replacement
Number of input points	2 points	4 points	○	
Insulation method	External input ↔ Internal circuit: Photocoupler Internal circuit ↔ Transmission circuit: Not insulated	External input ↔ Internal circuit: Not insulated Internal circuit ↔ Transmission circuit: Photocoupler	△	The insulated locations are different.
Input type	Positive/negative common shared type	Negative common type	△	A positive common type cannot be used.*1
Rated input voltage	24VDC	24VDC	○	
Rated input current	Approx. 7mA	Approx. 7mA	○	
Operating voltage range	21.6 to 26.4VDC (ripple voltage 4Vp-p or less)	21.6 to 27.6VDC (ripple voltage 0.5Vp-p or less)	△	Operating voltage range is different.
Maximum simultaneous on input point	100%	100%	○	
ON voltage/ON current	14VDC or higher/3.5mA or higher	16VDC or higher/4.5mA or higher	△	ON voltage and ON current are increased.*2
OFF voltage/OFF current	6VDC or lower/1.7mA or lower	6VDC or lower/1mA or lower	△	OFF current is decreased.*2
Input resistance	Approx. 3.3kΩ	Approx. 3.3kΩ	○	
Response time	OFF → ON	10ms or less	○	
	ON → OFF	10ms or less	○	
Common terminal arrangement	2 points per common (3-wire type terminal block)	4 points per common (2-wire type terminal block)	△	To connect an item such as a 3-wire type sensor, an external common terminal block is required.

Specifications		AJ55TB32-4DR output specifications	A20PB-04RS output specifications	Compat- ibility	Precautions for replacement
Number of output points		2 points	4 points	○	
Insulation method		External output ↔ Internal circuit: Photocoupler Internal circuit ↔ Transmission circuit: Not insulated	External output ↔ Internal circuit: Relay Internal circuit ↔ Transmission circuit: Photocoupler	△	The insulation method is different.
Output type		Contact output type	Contact output type	○	
Rated load voltage/current		24VDC 2A (resistance load)/point 240VAC 2A (COSφ=1)/point 4A/common	30VDC 2A (resistance load)/point 220VAC 2A (COSφ=1)/point 1A (induced load)/point	△	The rated load voltage and current are different.
Minimum switching load		5VDC 1mA	0.1VDC 0.1mA (reference value)	△	Check the specifications of the load to be used.
Maximum switching voltage		250VAC 110VDC	250VAC 110VDC	○	
Response time	OFF → ON	10ms or less	10ms or less	○	
	ON → OFF	12ms or less	10ms or less	○	
Life	Mechanical	20 million times or more	20 million times or more	○	
	Electrical	Rated switching voltage/current load 100,000 times or more 200VAC 1.5A, 240VAC 1A (COSφ=0.7) 100,000 times or more 200VAC 1A, 240VAC 0.5A (COSφ=0.35) 100,000 times or more 24VDC 1A, 100VDC 0.1A (L/R=7ms) 100,000 times or more	100,000 times or more	○	
Maximum switching frequency		3,600 times/hour	20 times/minute	△	Maximum switching frequency is different.
Surge suppressor		None	None	-	
Common terminal arrangement		2 points per common (2-wire type terminal block)	All points independent (2-wire type terminal block)	△	Because 2 points per common is changed to all points independent, the wiring is different.

*1 For the positive common type, use the A20SB-04U.

*2 Check the specifications of the sensors or switches to be connected to the A20SB-04US.

○ : Compatible, △ : Partially changed, × : Not compatible

Specifications		AJ55TB32-4DR	A20SB-04US	A20PB-04RS	Compat- ibility	Precautions for replacement
Operation indicator		ON indication (LED)		ON indication (LED)	○	
External wiring method		16-point terminal block (M3 screw) Transmission circuit included	10-point terminal block (M3 screw) Transmission circuit included	20-point terminal block (M3 screw) Transmission circuit included	△	Wiring must be changed. Existing wires can be used but applicable crimping terminals are different. For details, refer to Section 6.3.
Applicable wire size		0.75 to 2mm ²	0.3 to 1.25mm ² (when the following applicable crimping terminals are used: 0.75 to 2mm ²)		△	
Applicable crimping terminal		1.25-3, 1.25-YS3A, 2-S3, 2-YS3A V1.25-3, V1.25-YS3A, V2-S3, V2-YS3A	For wire sizes 0.75 to 2mm ² R2-3SL, RAV2-3SL, RAP2-3SL, VD2-3S, VD2-3.5SS, VD2-3.5S, VDAV2-3.5SS, VDAV2-3.5S		△	
External power supply	Voltage	24VDC ± 10% Ripple voltage 4Vp-p or less	-	-	-	External power supply for the A20SB-04US is unnecessary. The A20PB-04RS external power supply and the I/O module power supply are shared.
	Current	12mA (24VDC TYP. all points ON)	-	-	-	
I/O module power supply	Voltage	15.6 to 27.6VDC (peak voltage 27.6VDC)	21.6 to 27.6VDC (ripple voltage 0.5Vp-p or less)		△	Operating voltage range is different.
	Current	40mA	43mA	90mA	△	Because the current consumption has increased, the current capacity must be reviewed.
External dimensions		50(H) × 82(W) × 66(D) mm	40(H) × 65(W) × 60(D) mm	40(H) × 100(W) × 60(D) mm	×	The shape is different. A mounting space for two modules is required.
Installation method		Screw mounted	Screw mounted		×	Because mounting hole size is different, reworking is required.
		Mounted to DIN rail	Mounted to DIN rail		△	The A20SB-04US and A20PB-04RS can be mounted to the existing DIN rail. Be careful about the mounting dimensions as two modules are required.
Weight		0.2kg	0.09kg	0.14kg	△	The weight is increased.

(3) Comparisons between AJ55TB32-8DR and A20SB-04U + A20PB-04RS

○ : Compatible, △ : Partially changed, × : Not compatible

Specifications		AJ55TB32-8DR input specifications	A20SB-04U input specifications	Compat- ibility	Precautions for replacement
Number of input points		4 points	4 points	○	
Insulation method		External input ↔ Internal circuit: Photocoupler Internal circuit ↔ Transmission circuit: Not insulated	External input ↔ Internal circuit: Not insulated Internal circuit ↔ Transmission circuit: Photocoupler	△	The insulated locations are different.
Input type		Positive/negative common shared type	Positive common type	△	A negative common type cannot be used.*1
Rated input voltage		24VDC	24VDC	○	
Rated input current		Approx. 7mA	Approx. 7mA	○	
Operating voltage range		21.6 to 26.4VDC (ripple voltage 4Vp-p or less)	21.6 to 27.6VDC (ripple voltage 0.5Vp-p or less)	△	Operating voltage range is different.
Maximum simultaneous on input point		100%	100%	○	
ON voltage/ON current		14VDC or higher/3.5mA or higher	16VDC or higher/5.5mA or higher	△	ON voltage and ON current are increased.*2
OFF voltage/OFF current		6VDC or lower/1.7mA or lower	8VDC or lower/2mA or lower	△	OFF voltage and OFF current are increased.*2
Input resistance		Approx. 3.3kΩ	Approx. 3.3kΩ	○	
Response time	OFF → ON	10ms or less	1ms or less	○	
	ON → OFF	10ms or less	1ms or less	○	
Common terminal arrangement		4 points per common (3-wire type terminal block)	4 points per common (2-wire type terminal block)	△	To connect an item such as a 3-wire type sensor, an external common terminal block is required.

Specifications		AJ55TB32-8DR output specifications	A20PB-04RS output specifications	Compat- ibility	Precautions for replacement
Number of output points		4 points	4 points	○	
Insulation method		External output ↔ Internal circuit: Photocoupler Internal circuit ↔ Transmission circuit: Not insulated	External output ↔ Internal circuit: Relay Internal circuit ↔ Transmission circuit: Photocoupler	△	The insulation method is different.
Output type		Contact output type	Contact output type	○	
Rated load voltage/current		24VDC 2A (resistance load)/point 240VAC 2A (COSφ=1)/point 8A/common	30VDC 2A (resistance load)/point 220VAC 2A (COSφ=1)/point 1A (induced load)/point	△	The rated load voltage and current are different.
Minimum switching load		5VDC 1mA	0.1VDC 0.1mA (reference value)	△	Check the specifications of the load to be used.
Maximum switching voltage		250VAC 110VDC	250VAC 110VDC	○	
Response time	OFF → ON	10ms or less	10ms or less	○	
	ON → OFF	12ms or less	10ms or less	○	
Life	Mechanical	20 million times or more	20 million times or more	○	
	Electrical	Rated switching voltage/current load 100,000 times or more 200VAC 1.5A, 240VAC 1A (COSφ=0.7) 100,000 times or more 200VAC 1A, 240VAC 0.5A (COSφ=0.35) 100,000 times or more 24VDC 1A, 100VDC 0.1A (L/R=7ms) 100,000 times or more	100,000 times or more	○	
Maximum switching frequency		3,600 times/hour	20 times/minute	△	Maximum switching frequency is different.
Surge suppressor		None	None	-	
Common terminal arrangement		4 points per common (2-wire type terminal block)	All points independent (2-wire type terminal block)	△	Because 4 points per common is changed to all points independent, the wiring is different.

*1 For the negative common type, use the A20SB-04US.

*2 Check the specifications of the sensors or switches to be connected to the A20SB-04U.

○ : Compatible, △ : Partially changed, × : Not compatible

Specifications		AJ55TB32-8DR	A20SB-04U	A20PB-04RS	Compat- ibility	Precautions for replace- ment
Operation indicator		ON indication (LED)	ON indication (LED)		○	
External wiring method		24-point terminal block (M3 screw) Transmission circuit included	10-point terminal block (M3 screw) Transmission circuit included	20-point terminal block (M3 screw) Transmission circuit included	△	Wiring must be changed. Existing wires can be used but applicable crimping terminals are different. For details, refer to Section 6.3.
Applicable wire size		0.75 to 2mm ²	0.3 to 1.25mm ² (when the following applicable crimping terminals are used: 0.75 to 2mm ²)		△	
Applicable crimping terminal		1.25-3, 1.25-YS3A, 2-S3, 2-YS3A V1.25-3, V1.25-YS3A, V2-S3, V2-YS3A	For wire sizes 0.75 to 2mm ² R2-3SL, RAV2-3SL, RAP2-3SL, VD2-3S, VD2-3.5SS, VD2-3.5S, VDAV2-3.5SS, VDAV2-3.5S		△	
External power supply	Voltage	24VDC ± 10% Ripple voltage 4Vp-p or less	–	–	–	External power supply for the A20SB-04U is unnecessary. The A20PB-04RS external power supply and the I/O module power supply are shared.
	Current	23mA (24VDC TYP. all points ON)	–	–	–	
I/O module power supply	Voltage	15.6 to 27.6VDC	21.6 to 27.6VDC (ripple voltage 0.5Vp-p or less)		△	Operating voltage range is different.
	Current	50mA	50mA	90mA	△	Because the current consumption has increased, the current capacity must be reviewed.
External dimensions		50(H) × 114(W) × 66(D) mm	40(H) × 65(W) × 60(D) mm	40(H) × 100(W) × 60(D) mm	×	The shape is different. A mounting space for two modules is required.
Installation method		Screw mounted	Screw mounted		×	Because mounting hole size is different, reworking is required.
		Mounted to DIN rail	Mounted to DIN rail		△	The A20SB-04U and A20PB- 04RS can be mounted to the existing DIN rail. Be careful about the mounting dimensions as two modules are required.
Weight		0.3kg	0.09kg	0.14kg	○	

(4) Comparisons between AJ55TB32-8DR and A20SB-04US + A20PB-04RS

○ : Compatible, △ : Partially changed, × : Not compatible

Specifications	AJ55TB32-8DR input specifications	A20SB-04US input specifications	Compat-ibility	Precautions for replacement
Number of input points	4 points	4 points	○	
Insulation method	External input ↔ Internal circuit: Photocoupler Internal circuit ↔ Transmission circuit: Not insulated	External input ↔ Internal circuit: Not insulated Internal circuit ↔ Transmission circuit: Photocoupler	△	The insulated locations are different.
Input type	Positive/negative common shared type	Negative common type	△	A positive common type cannot be used.*1
Rated input voltage	24VDC	24VDC	○	
Rated input current	Approx. 7mA	Approx. 7mA	○	
Operating voltage range	21.6 to 26.4VDC (ripple voltage 4Vp-p or less)	21.6 to 27.6VDC (ripple voltage 0.5Vp-p or less)	△	Operating voltage range is different.
Maximum simultaneous on input point	100%	100%	○	
ON voltage/ON current	14VDC or higher/3.5mA or higher	16VDC or higher/4.5mA or higher	△	ON voltage and ON current are increased.*2
OFF voltage/OFF current	6VDC or lower/1.7mA or lower	6VDC or lower/1mA or lower	△	OFF current is decreased.*2
Input resistance	Approx. 3.3kΩ	Approx. 3.3kΩ	○	
Response time	OFF → ON	10ms or less	○	
	ON → OFF	10ms or less	○	
Common terminal arrangement	4 points per common (3-wire type terminal block)	4 points per common (2-wire type terminal block)	△	To connect an item such as a 3-wire type sensor, an external common terminal block is required.

Specifications		AJ55TB32-8DR output specifications	A20PB-04RS output specifications	Compat- ibility	Precautions for replacement
Number of output points		4 points	4 points	○	
Insulation method		External output ↔ Internal circuit: Photocoupler Internal circuit ↔ Transmission circuit: Not insulated	External output ↔ Internal circuit: Relay Internal circuit ↔ Transmission circuit: Photocoupler	△	The insulation method is different.
Output type		Contact output type	Contact output type	○	
Rated load voltage/current		24VDC 2A (resistance load)/point 240VAC 2A (COSφ=1)/point 8A/common	30VDC 2A (resistance load)/point 220VAC 2A (COSφ=1)/point 1A (induced load)/point	△	The rated load voltage and current are different.
Minimum switching load		5VDC 1mA	0.1VDC 0.1mA (reference value)	△	Check the specifications of the load to be used.
Maximum switching voltage		250VAC 110VDC	250VAC 110VDC	○	
Response time	OFF → ON	10ms or less	10ms or less	○	
	ON → OFF	12ms or less	10ms or less	○	
Life	Mechanical	20 million times or more	20 million times or more	○	
	Electrical	Rated switching voltage/current load 100,000 times or more 200VAC 1.5A, 240VAC 1A (COSφ=0.7) 100,000 times or more 200VAC 1A, 240VAC 0.5A (COSφ=0.35) 100,000 times or more 24VDC 1A, 100VDC 0.1A (L/R=7ms) 100,000 times or more	100,000 times or more	○	
Maximum switching frequency		3,600 times/hour	20 times/minute	△	Maximum switching frequency is different.
Surge suppressor		None	None	-	
Common terminal arrangement		4 points per common (2-wire type terminal block)	All points independent (2-wire type terminal block)	△	Because 4 points per common is changed to all points independent, the wiring is different.

*1 For the positive common type, use the A20SB-04U.

*2 Check the specifications of the sensors or switches to be connected to the A20SB-04US.

○ : Compatible, △ : Partially changed, × : Not compatible

Specifications		AJ55TB32-8DR	A20SB-04US	A20PB-04RS	Compat- ibility	Precautions for replacement
Operation indicator		ON indication (LED)	ON indication (LED)		○	
External wiring method		24-point terminal block (M3 screw) Transmission circuit included	24-point terminal block (M3 screw) Transmission circuit included	20-point terminal block (M3 screw) Transmission circuit included	△	Wiring must be changed. Existing wires can be used but applicable crimping terminals are different. For details, refer to Section 6.3.
Applicable wire size		0.75 to 2mm ²	0.3 to 1.25mm ² (when the following applicable crimping terminals are used: 0.75 to 2mm ²)		△	
Applicable crimping terminal		1.25-3, 1.25-YS3A, 2-S3, 2-YS3A V1.25-3, V1.25-YS3A, V2-S3, V2-YS3A	For wire sizes 0.75 to 2mm ² R2-3SL, RAV2-3SL, RAP2-3SL, VD2-3S, VD2-3.5SS, VD2-3.5S, VDAV2-3.5SS, VDAV2-3.5S		△	
External power supply	Voltage	24VDC ± 10% Ripple voltage 4Vp-p or less	-	-	-	External power supply for the A20SB-04U is unnecessary. The A20PB-04RS external power supply and the I/O module power supply are shared.
	Current	23mA (24VDC TYP. all points ON)	-	-	-	
I/O module power supply	Voltage	15.6 to 27.6VDC	21.6 to 27.6VDC (ripple voltage 0.5Vp-p or less)		△	Operating voltage range is different.
	Current	50mA	43mA	90mA	△	Because the current consumption has increased, the current capacity must be reviewed.
External dimensions		50(H) × 114(W) × 66(D) mm	40(H) × 65(W) × 60(D) mm	40(H) × 100(W) × 60(D) mm	×	The shape is different. A mounting space for two modules is required.
Installation method		Screw mounted	Screw mounted		×	Because mounting hole size is different, reworking is required.
		Mounted to DIN rail	Mounted to DIN rail		△	The A20SB-04US and A20PB-04RS can be mounted to the existing DIN rail. Be careful about the mounting dimensions as two modules are required.
Weight		0.3kg	0.09kg	0.14kg	○	

(5) Comparisons between AJ55TB32-16DR and A20SB-08UD + A20PB-08RS

○ : Compatible, △ : Partially changed, × : Not compatible

Specifications	AJ55TB32-16DR input specifications	A20SB-08UD input specifications	Compat-ibility	Precautions for replacement
Number of input points	8 points	8 points	○	
Insulation method	External input ↔ Internal circuit: Photocoupler Internal circuit ↔ Transmission circuit: Not insulated	External input ↔ Internal circuit: Not insulated Internal circuit ↔ Transmission circuit: Photocoupler	△	The insulated locations are different.
Input type	Positive/negative common shared type	Positive common type	△	A negative common type cannot be used.*1
Rated input voltage	24VDC	24VDC	○	
Rated input current	Approx. 7mA	Approx. 7mA	○	
Operating voltage range	21.6 to 26.4VDC (ripple voltage 4Vp-p or less)	21.6 to 27.6VDC (ripple voltage 0.5Vp-p or less)	△	Operating voltage range is different.
Maximum simultaneous on input point	100%	100%	○	
ON voltage/ON current	14VDC or higher/3.5mA or higher	16VDC or higher/5.5mA or higher	△	ON voltage and ON current are increased.*2
OFF voltage/OFF current	6VDC or lower/1.7mA or lower	8VDC or lower/2mA or lower	△	OFF voltage and OFF current are increased.*2
Input resistance	Approx. 3.3kΩ	Approx. 3.3kΩ	○	
Response time	OFF → ON	10ms or less	○	
	ON → OFF	10ms or less	○	
Common terminal arrangement	8 points per common (3-wire type terminal block)	8 points per common (3-wire type terminal block)	○	

Specifications	AJ55TB32-16DR output specifications	A20PB-08RS output specifications	Compat-ibility	Precautions for replacement
Number of output points	8 points	8 points	○	
Insulation method	External output ↔ Internal circuit: Photocoupler Internal circuit ↔ Transmission circuit: Not insulated	External output ↔ Internal circuit: Relay Internal circuit ↔ Transmission circuit: Photocoupler	△	The insulation method is different.
Output type	Contact output type	Contact output type	○	
Rated load voltage/current	24VDC 2A (resistance load)/point 240VAC 2A (COSφ=1)/point 8A/common	30VDC 2A (resistance load)/point 220VAC 2A (COSφ=1)/point 1A (induced load)/point	△	The rated load current is different.
Minimum switching load	5VDC 1mA	0.1VDC 0.1mA (reference value)	△	Check the specifications of the load to be used.
Maximum switching voltage	250VAC 110VDC	250VAC 110VDC	○	
Response time	OFF → ON	10ms or less	○	
	ON → OFF	12ms or less	○	
Life	Mechanical	20 million times or more	○	
	Electrical	Rated switching voltage/current load 100,000 times or more 200VAC 1.5A, 240VAC 1A (COSφ=0.7) 100,000 times or more 200VAC 1A, 240VAC 0.5A (COSφ=0.35) 100,000 times or more 24VDC 1A, 100VDC 0.1A (L/R=7ms) 100,000 times or more	100,000 times or more	○
Maximum switching frequency	3,600 times/hour	20 times/minute	△	Maximum switching frequency is different.
Surge suppressor	None	None	-	
Common terminal arrangement	8 points per common (2-wire type terminal block)	All points independent (2-wire type terminal block)	△	Because 8 points per common is changed to all points independent, the wiring is different.

*1 For the negative common type, use the A20SB-08USD-1.

*2 Check the specifications of the sensors or switches to be connected to the A20SB-08UD.

○ : Compatible, △ : Partially changed, × : Not compatible

Specifications		AJ55TB32-16DR	A20SB-08UD	A20PB-08RS	Compat- ibility	Precautions for replacement
Operation indicator		ON indication (LED)	ON indication (LED)		○	
External wiring method		40-point terminal block (M3 screw) Transmission circuit included	30-point terminal block (M3 screw) Transmission circuit included	30-point terminal block (M3 screw) Transmission circuit included	△	Wiring must be changed. Existing wires can be used but applicable crimping terminals are different. For details, refer to Section 6.3.
Applicable wire size		0.75 to 2mm ²	0.3 to 1.25mm ² (when the following applicable crimping terminals are used: 0.75 to 2mm ²)		△	
Applicable crimping terminal		1.25-3, 1.25-YS3A, 2-S3, 2-YS3A V1.25-3, V1.25-YS3A, V2-S3, V2-YS3A	For wire sizes 0.75 to 2mm ² R2-3SL, RAV2-3SL, RAP2-3SL, VD2-3S, VD2-3.5SS, VD2-3.5S, VDAV2-3.5SS, VDAV2-3.5S		△	
External power supply	Voltage	24VDC ± 10% Ripple voltage 4Vp-p or less	-	-	-	External power supply for the A20SB-08UD is unnecessary. The A20PB-08RS external power supply and the I/O module power supply are shared.
	Current	45mA (24VDC TYP. all points ON)	-	-	-	
I/O module power supply	Voltage	15.6 to 27.6VDC	21.6 to 27.6VDC (ripple voltage 0.5Vp-p or less)		△	Operating voltage range is different.
	Current	70mA	117mA	104mA	△	Because the current consumption has increased, the current capacity must be reviewed.
External dimensions		50(H) × 177(W) × 66(D) mm	40(H) × 140(W) × 60(D) mm	40(H) × 140(W) × 60(D) mm	×	The shape is different. A mounting space for two modules is required.
Installation method		Screw mounted	Screw mounted		×	Because mounting hole size is different, reworking is required.
		Mounted to DIN rail	Mounted to DIN rail		△	The A20SB-08UD and A20PB-08RS can be mounted to the existing DIN rail. Be careful about the mounting dimensions as two modules are required.
Weight		0.4kg	0.18kg	0.2kg	○	

(6) Comparisons between AJ55TB32-16DR and A20SB-08USD-1 + A20PB-08RS

○ : Compatible, △ : Partially changed, × : Not compatible

Specifications	AJ55TB32-16DR input specifications	A20SB-08USD-1 input specifications	Compat-ibility	Precautions for replacement
Number of input points	8 points	8 points	○	
Insulation method	External input ↔ Internal circuit: Photocoupler Internal circuit ↔ Transmission circuit: Not insulated	External input ↔ Internal circuit: Not insulated Internal circuit ↔ Transmission circuit: Photocoupler	△	The insulated locations are different.
Input type	Positive/negative common shared type	Negative common type	△	A positive common type cannot be used.*1
Rated input voltage	24VDC	24VDC	○	
Rated input current	Approx. 7mA	Approx. 7mA	○	
Operating voltage range	21.6 to 26.4VDC (ripple voltage 4Vp-p or less)	21.6 to 27.6VDC (ripple voltage 0.5Vp-p or less)	△	Operating voltage range is different.
Maximum simultaneous on input point	100%	100%	○	
ON voltage/ON current	14VDC or higher/3.5mA or higher	16VDC or higher/5.5mA or higher	△	ON voltage and ON current are increased.*2
OFF voltage/OFF current	6VDC or lower/1.7mA or lower	8VDC or lower/2mA or lower	△	OFF voltage and OFF current are increased.*2
Input resistance	Approx. 3.3kΩ	Approx. 3.3kΩ	○	
Response time	OFF → ON	10ms or less	○	
	ON → OFF	10ms or less	○	
Common terminal arrangement	8 points per common (3-wire type terminal block)	8 points per common (3-wire type terminal block)	○	

Specifications	AJ55TB32-16DR output specifications	A20PB-08RS output specifications	Compat-ibility	Precautions for replacement
Number of output points	8 points	8 points	○	
Insulation method	External output ↔ Internal circuit: Photocoupler Internal circuit ↔ Transmission circuit: Not insulated	External output ↔ Internal circuit: Relay Internal circuit ↔ Transmission circuit: Photocoupler	△	The insulation method is different.
Output type	Contact output type	Contact output type	○	
Rated load voltage/current	24VDC 2A (resistance load)/point 240VAC 2A (COSφ=1)/point 8A/common	30VDC 2A (resistance load)/point 220VAC 2A (COSφ=1)/point 1A (induced load)/point	△	The rated load current is different.
Minimum switching load	5VDC 1mA	0.1VDC 0.1mA (reference value)	△	Check the specifications of the load to be used.
Maximum switching voltage	250VAC 110VDC	250VAC 110VDC	○	
Response time	OFF → ON	10ms or less	○	
	ON → OFF	12ms or less	○	
Life	Mechanical	20 million times or more	○	
	Electrical	Rated switching voltage/current load 100,000 times or more 200VAC 1.5A, 240VAC 1A (COSφ=0.7) 100,000 times or more 200VAC 1A, 240VAC 0.5A (COSφ=0.35) 100,000 times or more 24VDC 1A, 100VDC 0.1A (L/R=7ms) 100,000 times or more	100,000 times or more	○
Maximum switching frequency	3,600 times/hour	20 times/minute	△	Maximum switching frequency is different.
Surge suppressor	None	None	-	
Common terminal arrangement	8 points per common (2-wire type terminal block)	All points independent (2-wire type terminal block)	△	Because 8 points per common is changed to all points independent, the wiring is different.

*1 For the negative common type, use the A20SB-08UD.

*2 Check the specifications of the sensors or switches to be connected to the A20SB-08USD-1.

○ : Compatible, △ : Partially changed, × : Not compatible

Specifications		AJ55TB32-16DR	A20SB-08USD-1	A20PB-08RS	Compat- ibility	Precautions for replacement
Operation indicator		ON indication (LED)	ON indication (LED)		○	
External wiring method		40-point terminal block (M3 screw) Transmission circuit included	30-point terminal block (M3 screw) Transmission circuit included	30-point terminal block (M3 screw) Transmission circuit included	△	Wiring must be changed. Existing wires can be used but applicable crimping terminals are different. For details, refer to Section 6.3.
Applicable wire size		0.75 to 2mm ²	0.3 to 1.25mm ² (when the following applicable crimping terminals are used: 0.75 to 2mm ²)		△	
Applicable crimping terminal		1.25-3, 1.25-YS3A, 2-S3, 2-YS3A V1.25-3, V1.25-YS3A, V2-S3, V2-YS3A	For wire sizes 0.75 to 2mm ² R2-3SL, RAV2-3SL, RAP2-3SL, VD2-3S, VD2-3.5SS, VD2-3.5S, VDAV2-3.5SS, VDAV2-3.5S		△	
External power supply	Voltage	24VDC ± 10% Ripple voltage 4Vp-p or less	–	–	–	External power supply for the A20SB-08USD-1 is unnecessary. The A20PB-08RS external power supply and the I/O module power supply are shared.
	Current	45mA (24VDC TYP. all points ON)	–	–	–	
I/O module power supply	Voltage	15.6 to 27.6VDC	21.6 to 27.6VDC (ripple voltage 0.5Vp-p or less)		△	Operating voltage range is different.
	Current	70mA	117mA	104mA	△	Because the current consumption has increased, the current capacity must be reviewed.
External dimensions		50(H) × 177(W) × 66(D) mm	40(H) × 140(W) × 60(D) mm	40(H) × 140(W) × 60(D) mm	×	The shape is different. A mounting space for two modules is required.
Installation method		Screw mounted	Screw mounted		×	Because mounting hole size is different, reworking is required.
		Mounted to DIN rail	Mounted to DIN rail		△	The A20SB-08USD-1 and A20PB-08RS can be mounted to the existing DIN rail. Be careful about the mounting dimensions as two modules are required.
Weight		0.4kg	0.25kg	0.2kg	△	The weight is increased.

(7) Comparisons between AJ55TB32-4DT and A20XB-16UD

○ : Compatible, △ : Partially changed, × : Not compatible

Specifications		AJ55TB32-4DT input specifications	A20XB-16UD input specifications	Compat-ibility	Precautions for replacement
Number of input points		2 points	8 points	○	
Insulation method		External input ↔ Internal circuit: Photocoupler Internal circuit ↔ Transmission circuit: Not insulated	External input ↔ Internal circuit: Not insulated Internal circuit ↔ Transmission circuit: Photocoupler	△	The insulated locations are different.
Input type		Positive common type	Positive common type	○	
Rated input voltage		24VDC	24VDC	○	
Rated input current		Approx. 7mA	Approx. 7mA	○	
Operating voltage range		19.2 to 26.4VDC (ripple ratio within 5%)	21.6 to 27.6VDC (ripple voltage 0.5Vp-p or less)	△	Operating voltage range is different.
Maximum simultaneous on input point		100%	100%	○	
ON voltage/ON current		14VDC or higher/3.5mA or higher	16VDC or higher/5mA or higher	△	ON voltage and ON current are increased.*1
OFF voltage/OFF current		6VDC or lower/1.7mA or lower	8VDC or lower/1.5mA or lower	△	OFF voltage is increased and OFF current is decreased.*1
Input resistance		Approx. 3.3kΩ	Approx. 3.3kΩ	○	
Response time	OFF → ON	10ms or less	1ms or less	○	
	ON → OFF	10ms or less	1ms or less	○	
Common terminal arrangement		2 points per common (3-wire type terminal block)	8 points per common (3-wire type terminal block)	○	

Specifications		AJ55TB32-4DT output specifications	A20XB-16UD output specifications	Compat-ibility	Precautions for replacement
Number of output points		2 points	8 points	○	
Insulation method		External output ↔ Internal circuit: Photocoupler Internal circuit ↔ Transmission circuit: Not insulated	External output ↔ Internal circuit: Not insulated Internal circuit ↔ Transmission circuit: Photocoupler	△	The insulated locations are different.
Output type		Sink type	Sink type	○	
Rated load voltage		24VDC	24VDC	○	
Operating load voltage range		19.2 to 26.4VDC (peak voltage 26.4VDC)	21.6 to 27.6VDC (ripple voltage 0.5Vp-p or less)	△	Operating voltage range is different.
Maximum load current		0.5A/point 1A/common	0.2A/point 1.6A/common	△	The maximum load current per point has decreased. Check the specifications of the load to be used.
Maximum inrush current		4A, 10ms or less	500mA or lower	△	Inrush current is decreased. Check the specifications of the load to be used.
Leakage current at OFF		0.1mA or lower	0.1mA or lower	○	
Maximum voltage drop at ON		0.9VDC or lower (TYP.) 0.5A 1.5VDC or lower (MAX.) 0.5A	1V or lower	△	Check the specifications of the load to be used.
Response time	OFF → ON	2.0ms or less	1ms or less	○	
	ON → OFF	2.0ms or less (resistance load)	1ms or less	○	
External power supply	Voltage	19.2 to 26.4VDC	–	–	The A20XB-16UD external power supply and the I/O module power supply are shared.
	Current	15mA (24VDC TYP. per common)	–	–	
Surge suppressor		Zener diode	None	×	The surge suppressor is not built-in.
Common terminal arrangement		2 points per common (2-wire type terminal block)	8 points per common (2-wire type terminal block)	○	

*1 Check the specifications of the sensors or switches to be connected to the A20XB-16UD.

Specifications		AJ55TB32-4DT	A20XB-16UD	Compat- ibility	Precautions for replacement
Operation indicator		ON indication (LED)	ON indication (LED)	○	
External wiring method		16-point terminal block (M3 screw) Transmission circuit included	40-point terminal block (M3 screw) Transmission circuit included	△	Wiring must be changed.
Applicable wire size		0.75 to 2mm ²	0.3 to 1.25mm ²	△	Existing wires can be used but applicable crimping terminals are different.
Applicable crimping terminal		1.25-3, 1.25-YS3A, 2-S3, 2-YS3A V1.25-3, V1.25-YS3A, V2-S3, V2-YS3A	For wire sizes 0.75 to 2mm ² R2-3SL, RAV2-3SL, RAP2-3SL, VD2-3S, VD2-3.5SS, VD2-3.5S, VDAV2-3.5SS, VDAV2-3.5S	△	For details, refer to Section 6.3.
I/O module power supply	Voltage	15.6 to 27.6VDC	21.6 to 27.6VDC (ripple voltage 0.5Vp-p or less)	△	Operating voltage range is different.
	Current	40mA	106mA	△	Because the current consumption has increased, the current capacity must be reviewed.
External dimensions		50(H) × 82(W) × 66(D) mm	40(H) × 190(W) × 60(D) mm	△	The shape is different.
Installation method		Screw mounted	Screw mounted	×	Because mounting hole size is different, reworking is required.
		Mounted to DIN rail	Mounted to DIN rail	○	The A20XB-16UD can be mounted to the existing DIN rail.
Weight		0.2kg	0.3kg	△	The weight is increased.

(8) Comparisons between AJ55TB32-8DT and A20XB-16UD

○ : Compatible, △ : Partially changed, × : Not compatible

Specifications		AJ55TB32-8DT input specifications	A20XB-16UD input specifications	Compat-ibility	Precautions for replacement
Number of input points		4 points	8 points	○	
Insulation method		External input ↔ Internal circuit: Photocoupler Internal circuit ↔ Transmission circuit: Not insulated	External input ↔ Internal circuit: Not insulated Internal circuit ↔ Transmission circuit: Photocoupler	△	The insulated locations are different.
Input type		Positive common type	Positive common type	○	
Rated input voltage		24VDC	24VDC	○	
Rated input current		Approx. 7mA	Approx. 7mA	○	
Operating voltage range		19.2 to 26.4VDC (ripple ratio within 5%)	21.6 to 27.6VDC (ripple voltage 0.5Vp-p or less)	△	Operating voltage range is different.
Maximum simultaneous on input point		100%	100%	○	
ON voltage/ON current		14VDC or higher/3.5mA or higher	16VDC or higher/5mA or higher	△	ON voltage and ON current are increased.*1
OFF voltage/OFF current		6VDC or lower/1.7mA or lower	8VDC or lower/1.5mA or lower	△	OFF voltage is increased and OFF current is decreased.*1
Input resistance		Approx. 3.3kΩ	Approx. 3.3kΩ	○	
Response time	OFF → ON	10ms or less	1ms or less	○	
	ON → OFF	10ms or less	1ms or less	○	
Common terminal arrangement		4 points per common (3-wire type terminal block)	8 points per common (3-wire type terminal block)	○	

Specifications		AJ55TB32-8DT output specifications	A20XB-16UD output specifications	Compat-ibility	Precautions for replacement
Number of output points		4 points	8 points	○	
Insulation method		External output ↔ Internal circuit: Photocoupler Internal circuit ↔ Transmission circuit: Not insulated	External output ↔ Internal circuit: Not insulated Internal circuit ↔ Transmission circuit: Photocoupler	△	The insulated locations are different.
Output type		Sink type	Sink type	○	
Rated load voltage		24VDC	24VDC	○	
Operating load voltage range		19.2 to 26.4VDC (peak voltage 26.4VDC)	21.6 to 27.6VDC (ripple voltage 0.5Vp-p or less)	△	Operating voltage range is different.
Maximum load current		0.5A/point 2A/common	0.2A/point 1.6A/common	△	The maximum load current per point has decreased. Check the specifications of the load to be used.
Maximum inrush current		4A, 10ms or less	500mA or lower	△	Inrush current is decreased. Check the specifications of the load to be used.
Leakage current at OFF		0.1mA or lower	0.1mA or lower	○	
Maximum voltage drop at ON		0.9VDC or lower (TYP.) 0.5A 1.5VDC or lower (MAX.) 0.5A	1V or lower	△	Check the specifications of the load to be used.
Response time	OFF → ON	2ms or less	1ms or less	○	
	ON → OFF	2ms or less (resistance load)	1ms or less	○	
External power supply	Voltage	19.2 to 26.4VDC	–	–	The A20XB-16UD external power supply and the I/O module power supply are shared.
	Current	30mA (24VDC TYP. per common)	–	–	
Surge suppressor		Zener diode	None	×	The surge suppressor is not built-in.
Common terminal arrangement		4 points per common (2-wire type terminal block)	8 points per common (2-wire type terminal block)	○	

*1 Check the specifications of the sensors or switches to be connected to the A20XB-16UD.

Specifications		AJ55TB32-8DT	A20XB-16UD	Compat- ibility	Precautions for replacement
Operation indicator		ON indication (LED)	ON indication (LED)	○	
External wiring method		24-point terminal block (M3 screw) Transmission circuit included	40-point terminal block (M3 screw) Transmission circuit included	△	
Applicable wire size		0.75 to 2mm ²	0.3 to 1.25mm ² (when the following applicable crimping terminals are used: 0.75 to 2mm ²)	△	Wiring must be changed. Existing wires can be used but applicable crimping terminals are different.
Applicable crimping terminal		1.25-3, 1.25-YS3A, 2-S3, 2-YS3A V1.25-3, V1.25-YS3A, V2-S3, V2-YS3A	For wire sizes 0.75 to 2mm ² R2-3SL, RAV2-3SL, RAP2-3SL, VD2-3S, VD2-3.5SS, VD2-3.5S, VDAV2-3.5SS, VDAV2-3.5S	△	For details, refer to Section 6.3.
I/O module power supply	Voltage	15.6 to 27.6VDC	21.6 to 27.6VDC (ripple voltage 0.5Vp-p or less)	△	Operating voltage range is different.
	Current	50mA	106mA	△	Because the current consumption has increased, the current capacity must be reviewed.
External dimensions		50(H) × 114(W) × 66(D) mm	40(H) × 190(W) × 60(D) mm	△	The shape is different.
Installation method		Screw mounted	Screw mounted	×	Because mounting hole size is different, reworking is required.
		Mounted to DIN rail	Mounted to DIN rail	○	The A20XB-16UD can be mounted to the existing DIN rail.
Weight		0.3kg	0.3kg	○	

(9) Comparisons between AJ55TB32-16DT and A20XB-16UD

○ : Compatible, △ : Partially changed, × : Not compatible

Specifications	AJ55TB32-16DT input specifications	A20XB-16UD input specifications	Compat-ibility	Precautions for replacement
Number of input points	8 points	8 points	○	
Insulation method	External input ↔ Internal circuit: Photocoupler Internal circuit ↔ Transmission circuit: Not insulated	External input ↔ Internal circuit: Not insulated Internal circuit ↔ Transmission circuit: Photocoupler	△	The insulated locations are different.
Input type	Positive common type	Positive common type	○	
Rated input voltage	24VDC	24VDC	○	
Rated input current	Approx. 7mA	Approx. 7mA	○	
Operating voltage range	19.2 to 26.4VDC (ripple ratio within 5%)	21.6 to 27.6VDC (ripple voltage 0.5Vp-p or less)	△	Operating voltage range is different.
Maximum simultaneous on input point	100%	100%	○	
ON voltage/ON current	14VDC or higher/3.5mA or higher	16VDC or higher/5mA or higher	△	ON voltage and ON current are increased.*1
OFF voltage/OFF current	6VDC or lower/1.7mA or lower	8VDC or lower/1.5mA or lower	△	OFF voltage is increased and OFF current is decreased.*1
Input resistance	Approx. 3.3kΩ	Approx. 3.3kΩ	○	
Response time	OFF → ON	10ms or less	○	
	ON → OFF	10ms or less	○	
Common terminal arrangement	8 points per common (3-wire type terminal block)	8 points per common (3-wire type terminal block)	○	

Specifications	AJ55TB32-16DT output specifications	A20XB-16UD output specifications	Compat-ibility	Precautions for replacement
Number of output points	8 points	8 points	○	
Insulation method	External output ↔ Internal circuit: Photocoupler Internal circuit ↔ Transmission circuit: Not insulated	External output ↔ Internal circuit: Not insulated Internal circuit ↔ Transmission circuit: Photocoupler	△	The insulated locations are different.
Output type	Sink type	Sink type	○	
Rated load voltage	24VDC	24VDC	○	
Operating load voltage range	19.2 to 26.4VDC (peak voltage 26.4VDC)	21.6 to 27.6VDC (ripple voltage 0.5Vp-p or less)	△	Operating voltage range is different.
Maximum load current	0.5A/point 4A/common	0.2A/point 1.6A/common	△	The maximum load current per point has decreased. Check the specifications of the load to be used.
Maximum inrush current	4A, 10ms or less	500mA or lower	△	Inrush current is decreased. Check the specifications of the load to be used.
Leakage current at OFF	0.1mA or lower	0.1mA or lower	○	
Maximum voltage drop at ON	0.9VDC or lower (TYP.) 0.5A 1.5VDC or lower (MAX.) 0.5A	1V or lower	△	Check the specifications of the load to be used.
Response time	OFF → ON	2ms or less	○	
	ON → OFF	2ms or less (resistance load)	○	
External power supply	Voltage	19.2 to 26.4VDC	–	The A20XB-16UD external power supply and the I/O module power supply are shared.
	Current	60mA (24VDC TYP. per common)	–	
Surge suppressor	Zener diode	None	×	The surge suppressor is not built-in.
Common terminal arrangement	8 points per common (2-wire type terminal block)	8 points per common (2-wire type terminal block)	○	

*1 Check the specifications of the sensors or switches to be connected to the A20XB-16UD.

Specifications		AJ55TB32-8DT	A20XB-16UD	Compat- ibility	Precautions for replacement
Operation indicator		ON indication (LED)	ON indication (LED)	○	
External wiring method		40-point terminal block (M3 screw) Transmission circuit included	40-point terminal block (M3 screw) Transmission circuit included	△	
Applicable wire size		0.75 to 2mm ²	0.3 to 1.25mm ² (when the following applicable crimping terminals are used: 0.75 to 2mm ²)	△	Wiring must be changed. Existing wires can be used but applicable crimping terminals are different.
Applicable crimping terminal		1.25-3, 1.25-YS3A, 2-S3, 2-YS3A V1.25-3, V1.25-YS3A, V2-S3, V2-YS3A	For wire sizes 0.75 to 2mm ² R2-3SL, RAV2-3SL, RAP2-3SL, VD2-3S, VD2-3.5SS, VD2-3.5S, VDAV2-3.5SS, VDAV2-3.5S	△	For details, refer to Section 6.3.
I/O module power supply	Voltage	15.6 to 27.6VDC	21.6 to 27.6VDC (ripple voltage 0.5Vp-p or less)	△	Operating voltage range is different.
	Current	70mA	106mA	△	Because the current consumption has increased, the current capacity must be reviewed.
External dimensions		50(H) × 177(W) × 66(D) mm	40(H) × 190(W) × 60(D) mm	△	The shape is different.
Installation method		Screw mounted	Screw mounted	×	Because mounting hole size is different, reworking is required.
		Mounted to DIN rail	Mounted to DIN rail	○	The A20XB-16UD can be mounted to the existing DIN rail.
Weight		0.4kg	0.3kg	○	

6.3 Applicable Crimping Terminal

Applicable crimping terminals are different between MELSEC-I/OLINK and AnyWire.
 This section describes whether it is necessary or not to change the crimping terminals when the existing external wiring for the MELSEC-I/OLINK is used.

(1) AnyWire terminal block

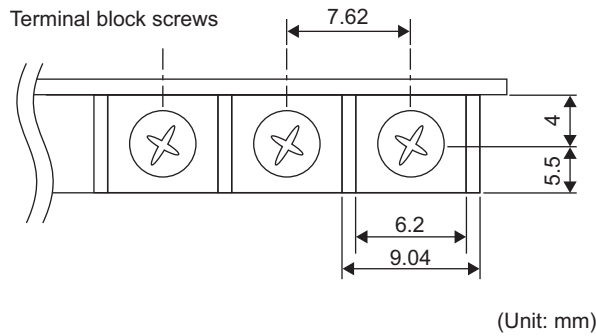

(2) Crimping terminal sizes

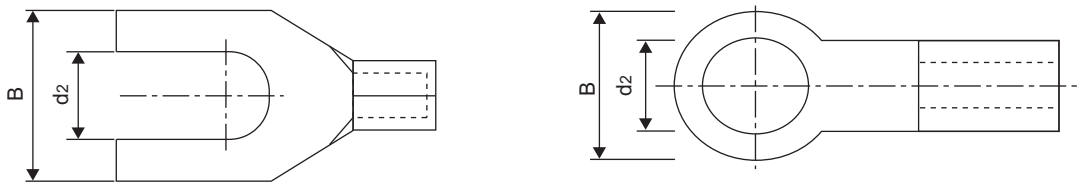

Crimping terminal model	Dimension (mm)		Remarks (restrictions)	
	B	d2		
I/OLINK Applicable crimping terminal	1.25-3	5.5	3.2	• If existing wires are used, the crimping terminals can also be used without changing them.
	V1.25-3			
	1.25-YS3A	6.4	3.7	• If existing wires are used, the crimping terminals must be changed.
	2-S3			
	2-YS3A			
	V1.25-YS3A			
	V2-S3			
	V2-YS3A			
AnyWire Applicable crimping terminal	R2-3SL	5.5	3.7	
	RAV2-3SL			
	RAP2-3SL			
	VD2-3S	5.7	3.3	
	VD2-3.5SL		3.7	
	VD2-3.5S			
	VDAV2-3.5SS			
	VDAV2-3.5S			

APPENDICES

Appendix 1 External Dimensions

For external dimensions of modules shown in this handbook, refer to the user's manual for each module.

Appendix 2 Relevant Manuals

Appendix 2.1 Replacement handbooks

(1) Transition guides

No.	Manual name	Manual number	Model code
1	MELSEC-A/QnA Series Transition Guide	L-08077E	--
2	MELSEC-AnS/QnAS (Small Type) Series Transition Guide	L-08236E	--

(2) Transition handbooks

No.	Manual name	Manual number	Model code
1	Transition from MELSEC-A/QnA (Large Type) Series to Q Series Handbook (Fundamentals)	L-08043ENG	--
2	Transition from MELSEC-A/QnA (Large Type) Series to Q Series Handbook (Intelligent Function Modules)	L-08046ENG	--
3	Transition from MELSEC-A/QnA (Large Type), AnS/QnAS (Small Type) Series to Q Series Handbook (Network Modules)	L-08048ENG	--
4	Transition from MELSEC-A/QnA (Large Type), AnS/QnAS (Small Type) Series to Q Series Handbook (Communications)	L-08050ENG	--
5	Transition from MELSEC-A0J2H Series to Q Series Handbook	L-08060ENG	--
6	Transition from MELSECNET/MINI-S3, A2C(I/O) to CC-Link Handbook	L-08061ENG	--
7	Transition from MELSEC-I/OLINK to CC-Link/LT Handbook	L-08062ENG	--
8	Transition of CPUs in MELSEC Redundant System Handbook (Transition from Q4ARCPU to QnPRHCPU)	L-08117ENG	--

(3) Transition examples manual

No.	Manual name	Manual number	Model code
1	MELSEC-A/QnA (Large), AnS/QnAS (Small) Transition Examples	L-08121E	--

Appendix 2.2 MELSEC-I/OLINK

No.	Manual name	Manual number	Model code
1	MELSEC-I/O Link Remote I/O System Master Module type AJ51T64/A1SJ51T64 User's Manual	IB-66574	13J748

Appendix 2.3 AnyWire DB A20

No.	Manual name	Manual number	Model code
1	MELSEC-Q AnyWire DB A20 Master Module User's Manual	SH-080968ENG	--

WARRANTY

Please confirm the following product warranty details before using this product.

1. Gratis Warranty Term and Gratis Warranty Range

If any faults or defects (hereinafter "Failure") found to be the responsibility of Mitsubishi occurs during use of the product within the gratis warranty term, the product shall be repaired at no cost via the sales representative or Mitsubishi Service Company.

However, if repairs are required onsite at domestic or overseas location, expenses to send an engineer will be solely at the customer's discretion. Mitsubishi shall not be held responsible for any re-commissioning, maintenance, or testing on-site that involves replacement of the failed module.

[Gratis Warranty Term]

The gratis warranty term of the product shall be for one year after the date of purchase or delivery to a designated place.

Note that after manufacture and shipment from Mitsubishi, the maximum distribution period shall be six (6) months, and the longest gratis warranty term after manufacturing shall be eighteen (18) months. The gratis warranty term of repair parts shall not exceed the gratis warranty term before repairs.

[Gratis Warranty Range]

- (1) The range shall be limited to normal use within the usage state, usage methods and usage environment, etc., which follow the conditions and precautions, etc., given in the instruction manual, user's manual and caution labels on the product.
- (2) Even within the gratis warranty term, repairs shall be charged for in the following cases.
 1. Failure occurring from inappropriate storage or handling, carelessness or negligence by the user. Failure caused by the user's hardware or software design.
 2. Failure caused by unapproved modifications, etc., to the product by the user.
 3. When the Mitsubishi product is assembled into a user's device, Failure that could have been avoided if functions or structures, judged as necessary in the legal safety measures the user's device is subject to or as necessary by industry standards, had been provided.
 4. Failure that could have been avoided if consumable parts (battery, backlight, fuse, etc.) designated in the instruction manual had been correctly serviced or replaced.
 5. Failure caused by external irresistible forces such as fires or abnormal voltages, and Failure caused by force majeure such as earthquakes, lightning, wind and water damage.
 6. Failure caused by reasons unpredictable by scientific technology standards at time of shipment from Mitsubishi.
 7. Any other failure found not to be the responsibility of Mitsubishi or that admitted not to be so by the user.

2. Onerous repair term after discontinuation of production

- (1) Mitsubishi shall accept onerous product repairs for seven (7) years after production of the product is discontinued.

Discontinuation of production shall be notified with Mitsubishi Technical Bulletins, etc.
- (2) Product supply (including repair parts) is not available after production is discontinued.

3. Overseas service

Overseas, repairs shall be accepted by Mitsubishi's local overseas FA Center. Note that the repair conditions at each FA Center may differ.

4. Exclusion of loss in opportunity and secondary loss from warranty liability

Regardless of the gratis warranty term, Mitsubishi shall not be liable for compensation of damages caused by any cause found not to be the responsibility of Mitsubishi, loss in opportunity, lost profits incurred to the user by Failures of Mitsubishi products, special damages and secondary damages whether foreseeable or not, compensation for accidents, and compensation for damages to products other than Mitsubishi products, replacement by the user, maintenance of on-site equipment, start-up test run and other tasks.

5. Changes in product specifications

The specifications given in the catalogs, manuals or technical documents are subject to change without prior notice.

Mitsubishi Programmable Controller

Country/Region	Sales office	Tel/Fax
USA	MITSUBISHI ELECTRIC AUTOMATION, INC. 500 Corporate Woods Parkway, Vernon Hills, IL 60061, U.S.A.	Tel : +1-847-478-2100 Fax : +1-847-478-2253
Mexico	MITSUBISHI ELECTRIC AUTOMATION, INC. Mexico Branch Mariano Escobedo #69, Col. Zona Industrial, Tlalnepantla Edo, C.P.54030, Mexico	Tel : +52-55-3067-7500
Brazil	MITSUBISHI ELECTRIC DO BRASIL COMÉRCIO E SERVIÇOS LTDA. Rua Jussara, 1750-Bloco B Anexo, Jardim Santa Cecilia, CEP 06465-070, Barueri-SP, Brasil	Tel : +55-11-4689-3000 Fax : +55-11-4689-3016
Germany	MITSUBISHI ELECTRIC EUROPE B.V. German Branch Gothaer Strasse 8, D-40880 Ratingen, Germany	Tel : +49-2102-486-0 Fax : +49-2102-486-1120
UK	MITSUBISHI ELECTRIC EUROPE B.V. UK Branch Travellers Lane, Hatfield, Hertfordshire, AL10 8XB, U.K.	Tel : +44-1707-28-8780 Fax : +44-1707-27-8695
Ireland	MITSUBISHI ELECTRIC EUROPE B.V. Irish Branch Westgate Business Park, Ballymount, IRL-Dublin 24, Ireland	Tel : +353-1-4198800 Fax : +353-1-4198890
Italy	MITSUBISHI ELECTRIC EUROPE B.V. Italian Branch Centro Direzionale Colleoni-Palazzo Sirio Viale Colleoni 7, 20864 Agrate Brianza(Milano) Italy	Tel : +39-039-60531 Fax : +39-039-6053-312
Spain	MITSUBISHI ELECTRIC EUROPE, B.V. Spanish Branch Carretera de Rubí, 76-80-Apdo. 420, 08173 Sant Cugat del Vallés (Barcelona), Spain	Tel : +34-935-65-3131 Fax : +34-935-89-1579
France	MITSUBISHI ELECTRIC EUROPE B.V. French Branch 25, Boulevard des Bouvets, F-92741 Nanterre Cedex, France	Tel : +33-1-55-68-55-68 Fax : +33-1-55-68-57-57
Czech Republic	MITSUBISHI ELECTRIC EUROPE B.V. Czech Branch Avenir Business Park, Radlicka 751/113e, 158 00 Praha5, Czech Republic	Tel : +420-251-551-470 Fax : +420-251-551-471
Poland	MITSUBISHI ELECTRIC EUROPE B.V. Polish Branch ul. Krakowska 50, 32-083 Balice, Poland	Tel : +48-12-630-47-00 Fax : +48-12-630-47-01
Sweden	MITSUBISHI ELECTRIC EUROPE B.V. (Scandinavia) Fjellievägen 8, SE-22736 Lund, Sweden	Tel : +46-8-625-10-00 Fax : +46-46-39-70-18
Russia	MITSUBISHI ELECTRIC EUROPE B.V. Russian Branch St. Petersburg office Piskarevsky pr. 2, bld 2, lit "Sch", BC "Benua", office 720; RU-195027 St. Petersburg, Russia	Tel : +7-812-633-3497 Fax : +7-812-633-3499
Turkey	MITSUBISHI ELECTRIC TURKEY A. Ş Ümraniye Branch Serifali Mahallesi Nutuk Sokak No:5, TR-34775 Umraniye, Istanbul, Turkey	Tel : +90-216-526-3990 Fax : +90-216-526-3995
Dubai	MITSUBISHI ELECTRIC EUROPE B.V. Dubai Branch Dubai Silicon Oasis, P.O.BOX 341241, Dubai, U.A.E.	Tel : +971-4-3724716 Fax : +971-4-3724721
South Africa	ADROIT TECHNOLOGIES 20 Waterford Office Park, 189 Witkoppen Road, Fourways, Johannesburg, South Africa	Tel : +27-11-658-8100 Fax : +27-11-658-8101
China	MITSUBISHI ELECTRIC AUTOMATION (CHINA) LTD. No.1386 Hongqiao Road, Mitsubishi Electric Automation Center, Shanghai, China	Tel : +86-21-2322-3030 Fax : +86-21-2322-3000
Taiwan	SETSUYO ENTERPRISE CO., LTD. 6F, No.105, Wugong 3rd Road, Wugu District, New Taipei City 24889, Taiwan, R.O.C.	Tel : +886-2-2299-2499 Fax : +886-2-2299-2509
Korea	MITSUBISHI ELECTRIC AUTOMATION KOREA CO., LTD. 7F-9F, Gangseo Hangang Xi-tower A, 401, Yangcheon-ro, Gangseo-Gu, Seoul 157-801, Korea	Tel : +82-2-3660-9530 Fax : +82-2-3664-8372
Singapore	MITSUBISHI ELECTRIC ASIA PTE. LTD. 307, Alexandra Road, Mitsubishi Electric Building, Singapore 159943	Tel : +65-6473-2308 Fax : +65-6476-7439
Thailand	MITSUBISHI ELECTRIC FACTORY AUTOMATION (THAILAND) CO., LTD. 12th Floor, SV.City Building, Office Tower 1, No. 896/19 and 20 Rama 3 Road, Kwaeng Bangpongpan, Khet Yannawa, Bangkok 10120, Thailand	Tel : +66-2682-6522 Fax : +66-2682-6020
Vietnam	MITSUBISHI ELECTRIC VIETNAM COMPANY LIMITED Hanoi Branch 6-Floor, Detech Tower, 8 Ton That Thuyet Street, My Dinh 2 Ward, Nam Tu Liem District, Hanoi, Vietnam	Tel : +84-4-3937-8075 Fax : +84-4-3937-8076
Indonesia	PT. MITSUBISHI ELECTRIC INDONESIA Gedung Jaya 11th Floor, JL. MH. Thamrin No.12, Jakarta Pusat 10340, Indonesia	Tel : +62-21-3192-6461 Fax : +62-21-3192-3942
India	MITSUBISHI ELECTRIC INDIA PVT. LTD. Pune Branch Emerald House, EL-3, J Block, M.I.D.C Bhosari, Pune-411026, Maharashtra, India	Tel : +91-20-2710-2000 Fax : +91-20-2710-2100
Australia	MITSUBISHI ELECTRIC AUSTRALIA PTY. LTD. 348 Victoria Road, P.O. Box 11, Rydalmere, N.S.W 2116, Australia	Tel : +61-2-9684-7777 Fax : +61-2-9684-7245

Mitsubishi Electric Corporation Nagoya Works is a factory certified for ISO 14001 (standards for environmental management systems) and ISO 9001 (standards for quality assurance management systems)

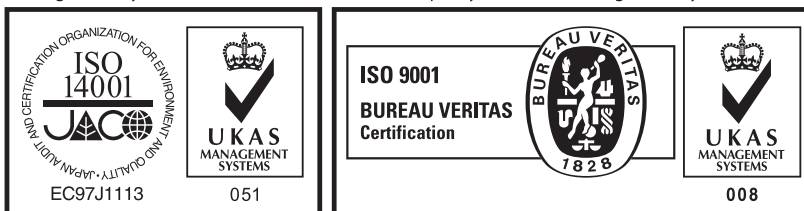

MITSUBISHI ELECTRIC CORPORATION

HEAD OFFICE: TOKYO BUILDING, 2-7-3, MARUNOUCHI, CHIYODA-KU, TOKYO 100-8310, JAPAN
NAGOYA WORKS: 1-14, YADA-MINAMI 5, HIGASHI-KU, NAGOYA, JAPAN